

SITORAN TECHNOLOGY EMPRESAS

CATALOGO



METALGRUPSA®

ACCESORIOS FONTANERIA

MultiGrup  
PexGrup  
Catálogo 2015

Catálogo Catalogue 2015



**MIA GRUPSA<sup>®</sup>**

*85th Anniversary*



**MONTSERRAT**  
since 1930

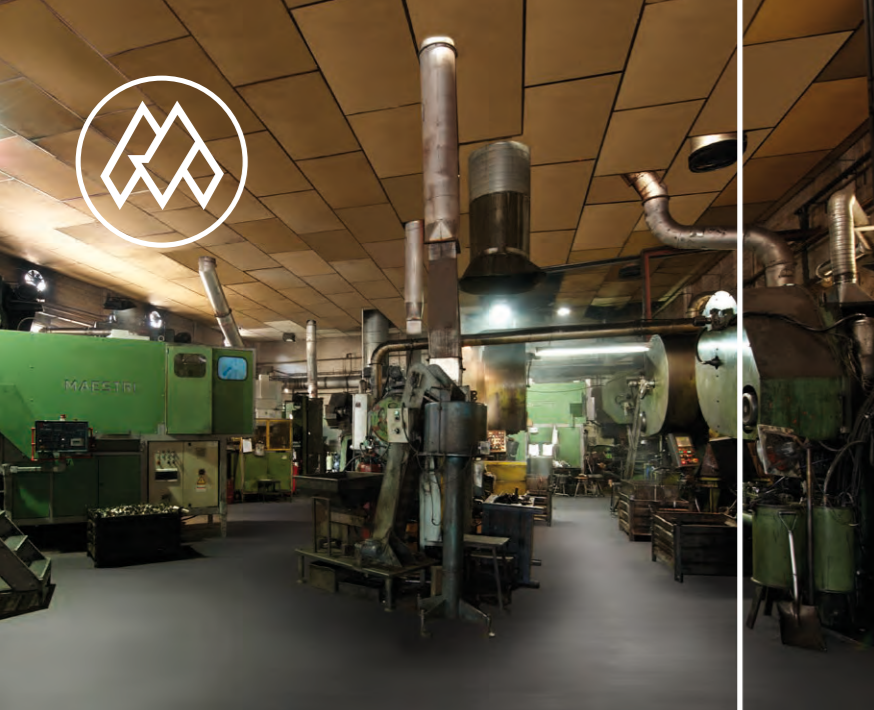

**METALGRUP, S.A.** is a company founded in 1983, derived from Montserrat Group (founded in 1930). Our speciality is the **INTEGRAL MANUFACTURING of STAMPED BRASS FITTINGS**, consisting of bars and ingots production at the smelter, cutting back plugs for stamping and machining, packaging and storage of products against stock to provide permanent availability thereof and logistics distribution to over 40 countries.

In this **General Catalogue 2015** you will find an extensive range of products with a wide range of diameters , different surface finishes (yellow brass, chromium-plated, nicked or tined) and presentations in different conditionings (bulk, bagged and fitted in different units, high frequency blister and customized presentations) as well as the ability to design and produce on demand any fitting and/or component in brass and conditioning customized following customers requirements.

**METALGRUP, S.A.** es una compañía fundada en 1983, derivada del Grupo Montserrat (fundado en 1930). Nuestra especialidad es la **FABRICACIÓN INTEGRAL de RACORERÍA DE LATÓN ESTAMPADO**, que consta de fabricación de barras y lingotes en la fundición, corte de tacos para estampación y posterior mecanización, acondicionamiento de productos y almacenaje contra stock para ofrecer disponibilidad permanente de los mismos y logística para su distribución a más de 40 países.

En éste **Catálogo General 2015** encontrarán una extensa gama de productos con una amplia variedad de diámetros, diversos acabados superficiales (latón amarillo, cromado, niquelado o estañado) y presentaciones en diferentes acondicionamientos (granel, embolsado y encajado de diferentes unidades, blister de alta frecuencia y presentaciones personalizadas), así como la capacidad de diseñar y producir bajo demanda cualquier tipo de accesorio y/o componente en latón y su acondicionamiento personalizado según requerimientos de nuestros clientes.

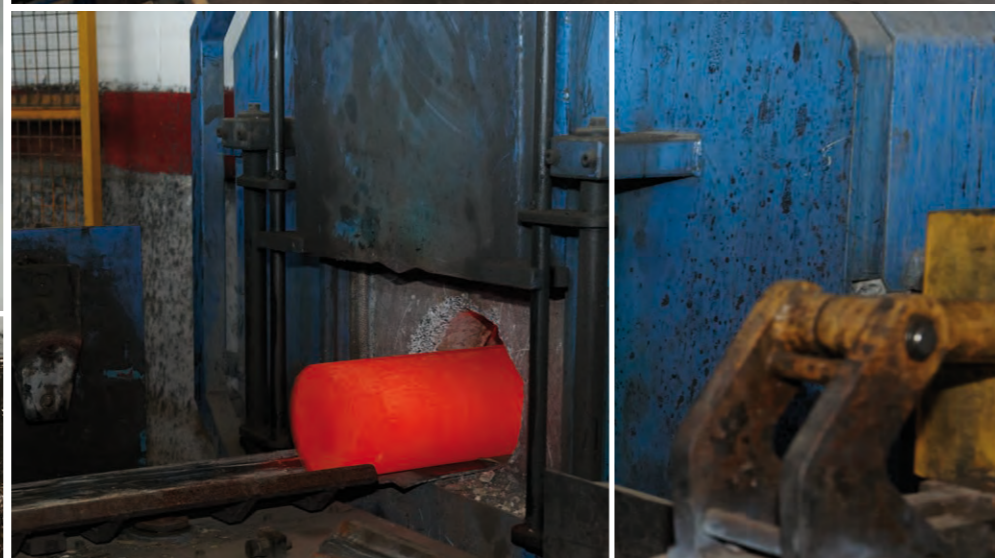
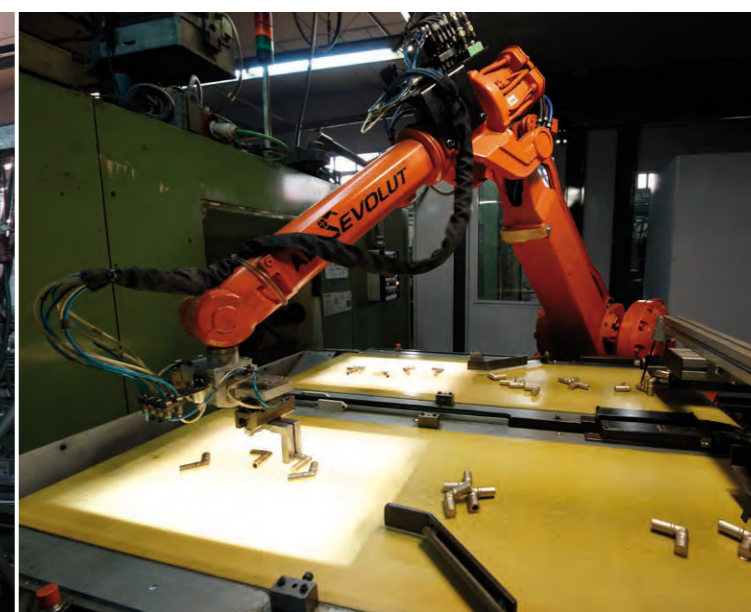

**METALGRUP, S.A.** est une société créée en 1983, dérivée du Groupe Montserrat (fondé en 1930). Notre spécialité est la **FABRICATION INTEGRALE de RACCORDS EN LAITON MATRIÇE**, comprennent la fabrication de barres et lingots à la fonderie, coupage des barres pour le matriçage et ultérieur usinage, conditionnement des produits et magasinage contre stock pour offrir une disponibilité permanente des mêmes et logistique pour sa distribution à plus de 40 pays.

En ce **Catálogo Général 2015** vous trouverez une large gamme de produits avec une vaste variété de diamètres, différentes finitions superficielles (laiton jaune, chromé, niquelé ou étamé) et des présentations en plusieurs conditionnements (vrac, ensaché et encaissé en boîtes de différentes unités, blister haute fréquence et des présentations personnalisées), ainsi que la capacité de dessiner et produire sous demande toute sorte d'accessoire et/ou élément en laiton et son conditionnement personnalisé selon les besoins de nos clients.



Caja dispensadora con embolsado unitario / Dispenser box with individual packing / Boîte dispensatrice avec sachets unitaires



Caja troquelada / Easy to open Die Cut Boxes / Boîte découpée



# Ra<sup>01</sup>

## Racorería de Latón

Brass Fittings  
*Raccords Laiton*

pág. 12-59

# Vc<sup>02</sup>

## Válvulas y Conexiones

Valves and Stainless Steel Hoses  
*Vannes et Flexibles Sanitaires*

pág. 60-73

# Gr<sup>03</sup>

## Grifería

Taps  
*Robinetterie*

pág. 74-95

# Ba<sup>04</sup>

## Complementos de Baño

Bathroom Complements  
*Accessoires Salle de Bain*

pág. 96-120

# Ra<sup>01</sup>



14



15



16



17



18



19



20

21



21



22

23



24



25



26



27



28

29



30



31

32



33



34



35



36



37



38



39



40



40



41



42



Ra<sup>01</sup>

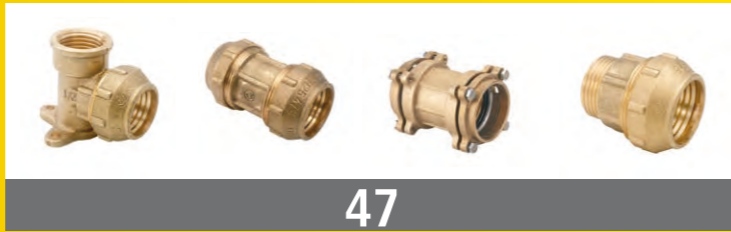

Vc<sup>02</sup>

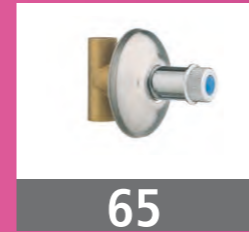

# Gr<sup>03</sup>



76



77



78



78



79

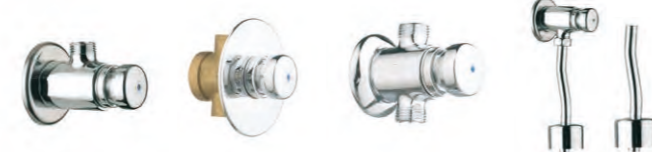

80



81



82



83



84



85



86



87



87



88



89



90



91



92



93



94



95

# Ba<sup>04</sup>



98



99



100



101



103



103



103



104



105



106



107



108



109



109



110



111



111



112



113



114



115

# Ra<sup>01</sup>

## Racorería de Latón Brass Fittings *Raccords Laiton*

Fabricado según Norma EN1254/4 & EN1254/1 con latón según Norma EN12164, EN12165 y EN1982.

GAS: Fabricado según Norma UNE 60719:2001.

Nipples Hierro: Fabricado según Norma EN10255.

Made under EN1254/4 & EN1254/1 Norms with brass under EN12164, EN12165 & EN1982 Norms.

GAS: Made under UNE 60719:2001 Norm.

Iron Nipples: Made under EN10255 Norm.

Produit selon Normes EN1254/4 & EN1254/1 avec laiton selon Normes EN12164, EN12165 & EN1982.

GAZ: Produit selon Norme UNE 60719:2001.

Nipples Fer: Produit selon Norme EN10255.

**Racorería de Latón para Roscar**  
Screw Brass Fittings / *Raccords Laiton à Viser*



14

**Racorería de Latón para Soldar**  
Soldering Brass fittings / *Raccords Laiton à Souder*



35

**Racorería de Latón para Tubo de Polietileno**  
Brass Fittings for Polyethylene Pipe / *Raccords Laiton pour Tube Polyéthylène*



46

**Riego**  
Irrigation / *Arrosage*



50

**Complementos Cisterna WC**  
WC Tank Complements / *Accessoires Réservoir WC*



53

Racorería de Latón para Roscar / Screw Brass Fittings / Raccords Laiton à Viser

Raccords Laiton à Viser / Screw Brass Fittings / Racorería de Latón para Roscar

Contrarrosca M-M (TH280) / Hexagonal Nipple M-M (TH280) / Mamelon Egal M-M (8280)



CÓDIGO	CÓDIGO EAN	ARTÍCULO	BOLSA	PRECIO (€)
313333	8423545016381	1/8"x1/8"	25	1,10
313444	8423545016428	1/4"x1/4"	25	0,99
313101	8423545016275	3/8"x3/8"	25	0,82
313202	8423545016305	1/2"x1/2"	25	1,05
313202A	8423545016312	1/2" REFORZADA	25	1,34
313303	8423545075234	3/4"x3/4"	25	1,56
313404	8423545016398	1"x1"	10	3,02
313505	8423545075241	1" 1/4x1" 1/4	-	6,17
313606	8423545016442	1" 1/2x1" 1/2	-	7,89
313707	8423545016459	2"x2"	-	10,86
313808	8423545016466	2" 1/2x2" 1/2	-	18,75
313909	8423545016473	3"x3"	-	28,80
313000	8423545016268	4"x4"	-	89,92

Cromado / Chromium-plated / Chromé

CÓDIGO	CÓDIGO EAN	ARTÍCULO	BOLSA	PRECIO (€)
313111	8423545016299	3/8"x3/8"	25	1,27
313212	8423545016336	1/2"x1/2"	25	1,45
313313	8423545016374	3/4"x3/4"	25	1,96
313414	8423545016411	1"x1"	10	3,42

Económico / Economic / Economique

CÓDIGO	CÓDIGO EAN	ARTÍCULO	BOLSA	PRECIO (€)
313222	8423545016343	1/2"x1/2"	25	0,94
313323	8423545105320	3/4"x3/4"	25	1,42
313424	8423545105337	1"x1"	10	2,56
313525	8423545129906	1" 1/4x1" 1/4	-	4,45

Disponible en acabado NIQUELADO bajo pedido  
Available in NICKELLED finition by order / Disponible en finition NIQUELE sous commande

Junta plana / Flat Joint / Joint plat

CÓDIGO	CÓDIGO EAN	ARTÍCULO	BOLSA	PRECIO (€)
313101F	8423545060384	3/8"x3/8"	10	0,99
313202F	8423545059265	1/2"x1/2"	10	1,25
313303F	8423545059234	3/4"x3/4"	10	1,76
313404F	8423545059203	1"x1"	10	3,35
313505F	8423545087381	1" 1/4x1" 1/4	-	6,69
313606F	8423545087398	1" 1/2x1" 1/2	-	9,40
313707F	8423545087404	2"x2"	-	14,29

Chromé Joint Plat / Chromium-plated Flat Joint / Cromado Junta Plana

CÓDIGO	CÓDIGO EAN	ARTÍCULO	BOLSA	PRECIO (€)
313111F	8423545068915	3/8"x3/8"	10	1,32
313212F	8423545068625	1/2"x1/2"	10	1,65
313313F	8423545068939	3/4"x3/4"	10	2,16
313414F	8423545068922	1"x1"	10	3,75

Mamelon Réduit M-M (8245) / Hexagonal Reducer Nipple M-M (TH245) / Contrarrosca Reducida M-M (TH245)

CÓDIGO	CÓDIGO EAN	ARTÍCULO	BOLSA	PRECIO (€)
314334	8423545016633	1/8"x1/4"	25	1,30
314331	8423545016626	1/8"x3/8"	25	1,99
314441	8423545016671	1/4"x3/8"	25	1,11
314244	8423545084724	1/2"x1/4"	25	1,12
314102	8423545064498	3/8"x1/2"	25	1,05
314203	8423545016510	1/2"x3/4"	25	1,47
314204	8423545016534	1/2"x1"	10	2,49
314304	8423545016565	3/4"x1"	10	2,59
314305	8423545016589	3/4"x1" 1/4	-	4,67
314405	8423545016640	1"x1" 1/4	-	5,19
314306	8423545016596	3/4"x1" 1/2	-	6,50
314406	8423545016657	1"x1" 1/2	-	6,34
314506	8423545016695	1" 1/4x1" 1/2	-	6,65
314307	8423545016602	3/4"x2"	-	9,70
314407	8423545016664	1"x2"	-	10,73
314507	8423545016701	1" 1/4x2"	-	9,36
314607	8423545016718	1" 1/2x2"	-	10,34
314708	8423545016732	2"x2" 1/2	-	18,22
314709	8423545016749	2"x3"	-	27,96
314809	8423545016763	2" 1/2x3"	-	28,33
314900	8423545016770	3"x4"	-	61,00



Chromé / Chromium-plated / Cromado

CÓDIGO	CÓDIGO EAN	ARTÍCULO	BOLSA	PRECIO (€)
314112	8423545016503	3/8"x1/2"	25	1,38
314213	8423545016558	1/2"x3/4"	25	1,87

Racorería de Latón para Roscar / Screw Brass Fittings / Raccords Laiton à Viser

Raccords Laiton à Viser / Screw Brass Fittings / Racorería de Latón para Roscar

Económico / Economic / Economique

CÓDIGO	CÓDIGO EAN	ARTÍCULO	BOLSA	PRECIO (€)
314122	8423545068700	3/8"x1/2"	25	0,87
314223	8423545105764	1/2"x3/4"	25	1,28
314324	8423545105344	3/4"x1"	10	2,25
314425	8423545129913	1"x1" 1/4	-	4,28

Disponibile en acabado NIQUELADO bajo pedido  
Available in NICKLELED finition by order / Disponible en finition NIQUELE sous commande

Junta Plana / Flat Joint / Joint Plat

CÓDIGO	CÓDIGO EAN	ARTÍCULO	BOLSA	PRECIO (€)
314102F	8423545059258	3/8"x1/2"	10	1,12
314203F	8423545059258	1/2"x3/4"	10	1,85
314304F	8423545059197	3/4"x1"	10	2,89

Racor Marsella M-H (TH529) / Hexagonal Equal Bushing M-F (TH529) / Mamelon Egal M-F (8529)



CÓDIGO	CÓDIGO EAN	ARTÍCULO	BOLSA	PRECIO (€)
352444	8423545018736	1/4"x1/4"	25	1,15
352101	8423545018552	3/8"x3/8"	25	0,74
352202	8423545018934	1/2"x1/2"	25	1,13
352202A	8423545018590	1/2" REFORZADA	25	1,31
352242	8423545018644	1/2"x1/2"x2cm	25	1,68
352252	8423545018651	1/2"x1/2"x3cm	25	2,33
352232	8423545079584	1/2"x1/2" HEXAG.INT.	25	1,59
352303	8423545018675	3/4"x3/4"	25	1,80
352404	8423545018705	1"x1"	10	3,23
352505	8423545018743	1" 1/4x1" 1/4	-	6,26
352606	8423545018750	1" 1/2x1" 1/2	-	8,45
352707	8423545018767	2"x2"	-	12,57

Cromado / Chromium-plated / Chromé

CÓDIGO	CÓDIGO EAN	ARTÍCULO	BOLSA	PRECIO (€)
352111	8423545018576	3/8"x3/8"	25	1,08
352212	8423545018613	1/2"x1/2"	25	1,53
352313	8423545018699	3/4"x3/4"	25	2,10
352414	8423545018729	1"x1"	10	3,99

Económico / Economic / Economique

CÓDIGO	CÓDIGO EAN	ARTÍCULO	BOLSA	PRECIO (€)
352222	8423545018637	1/2"x1/2"	25	1,01
352323	8423545105474	3/4"x3/4"	25	1,65
352424	8423545105771	1"x1"	10	2,89
352525	8423545130223	1" 1/4x1" 1/4	-	4,79

Disponibile en acabado NIQUELADO bajo pedido  
Available in NICKLELED finition by order / Disponible en finition NIQUELE sous commande

Joint Plat / Flat Joint / Junta Plana

CÓDIGO	CÓDIGO EAN	ARTÍCULO	BOLSA	PRECIO (€)
352101F	8423545061107	3/8"x3/8"	10	0,89
352202F	8423545059163	1/2"x1/2"	10	1,34
352303F	8423545059180	3/4"x3/4"	10	2,04
352404F	8423545061114	1"x1"	10	2,89

Mamelon Réduit M-F (8241) / Hexagonal Reducing Bushing M-F (TH241) / Racor Marsella Reducido M-H (TH241)

CÓDIGO	CÓDIGO EAN	ARTÍCULO	BOLSA	PRECIO (€)
353443	8423545019177	1/4"x1/8"	25	1,54
353133	8423545018811	3/8"x1/8"	25	1,78
353144	8423545018828	3/8"x1/4"	25	1,19
353201	8423545018835	1/2"x3/8"	25	1,23
353552	8423545019214	5/8"x1/2"	25	2,07
353302	8423545018965	3/4"x1/2"	25	2,12
353402	8423545019085	1"x1/2"	10	4,45
353403	8423545019108	1"x3/4"	10	3,60



Mamelon Réduit M-F (8246) / Hexagonal Reducing Bushing M-F (TH246) / Racor Marsella Reducido M-H (TH246)

CÓDIGO	CÓDIGO EAN	ARTÍCULO	BOLSA	PRECIO (€)
353334	8423545019061	1/8"x1/4"	25	1,55
353441	8423545019153	1/4"x3/8"	25	1,13
353102	8423545018781	3/8"x1/2"	25	1,07
353103	8423545079546	3/8"x3/4"	25	1,98
353255	8423545018958	1/2"x5/8"	25	2,16
353203	8423545018859	1/2"x3/4"	25	1,62
353204	8423545018873	1/2"x1"	10	2,86
353205	8423545018897	1/2"x1" 1/4	-	5,75
353304	8423545018996	3/4"x1"	10	2,79
353305	8423545019016	3/4"x1" 1/4	-	5,95
353307	8423545019023	3/4"x2"	-	11,20
353405	8423545019115	1"x1" 1/4	-	5,30
353406	8423545019122	1"x1" 1/2	-	6,80
353407	8423545019139	1"x2"	-	11,41
353506	8423545019191	1" 1/4x1" 1/2	-	6,84
353507	8423545019207	1" 1/4x2"	-	11,80
353607	8423545019238	1" 1/2x2"	-	12,80
353708	8423545019245	2"x2" 1/2	-	18,94



Racorería de Latón para Roscar / Screw Brass Fittings / Raccords Laiton à Viser

Raccords Laiton à Viser / Screw Brass Fittings / Racorería de Latón para Roscar

Racor Marsella Reducido M-H (TH246) / Hexagonal Reducing Bushing M-F (TH246) / Mamelon Réduit M-F (8246)



**Cromado / Chromium-plated / Chromé**

CÓDIGO	CÓDIGO EAN	ARTÍCULO	BOLSA	PRECIO (€)
353112	8423545018804	3/8"x1/2"	25	1,40
353113	8423545079553	3/8"x3/4"	25	2,33
353211	8423545018903	1/2"x3/8"	25	1,50
353213	8423545018910	1/2"x3/4"	25	1,94
353312	8423545019030	3/4"x1/2"	25	2,52

**Económico / Economic / Economique**

CÓDIGO	CÓDIGO EAN	ARTÍCULO	BOLSA	PRECIO (€)
353122	8423545068717	3/8"x1/2"	25	0,88
353223	8423545105788	1/2"x3/4"	25	1,49
353324	8423545105795	3/4"x1"	10	2,48
353425	8423545129920	1"Mx1" 1/4H	-	4,80

Disponibile en acabado NIQUELADO bajo pedido  
Available in NICKLELED finition by order / Disponible en finition NIQUELE sous commande

**Junta Plana / Flat Joint / Joint Plat**

CÓDIGO	CÓDIGO EAN	ARTÍCULO	BOLSA	PRECIO (€)
353102F	8423545059277	3/8"x1/2"	10	1,43
353201F	8423545060391	1/2"x3/8"	10	1,40
353203F	8423545060407	1/2"x3/4"	10	1,98
353302F	8423545060414	3/4"x1/2"	10	1,76
353304F	8423545059289	3/4"x1"	10	2,71
353403F	8423545060421	1"x3/4"	10	2,98

**Cromado Junta Plana / Chromium-plated Flat Joint / Chromé Joint Plat**

CÓDIGO	CÓDIGO EAN	ARTÍCULO	BOLSA	PRECIO (€)
353112F	8423545068946	3/8"x1/2"	10	1,81
353211F	8423545068953	1/2"x3/8"	10	1,71
353213F	8423545068960	1/2"x3/4"	10	2,31

Réduction Hexagonale M-F (8241) / Hexagonal Reducer Bushing M-F (TH241) / Reducción Hexagonal M-H (TH241)



CÓDIGO	CÓDIGO EAN	ARTÍCULO	BOLSA	PRECIO (€)
392344	8423545021248	1/4"x1/8"	25	0,99
392133	8423545021118	3/8"x1/8"	25	0,76
392144	8423545021125	3/8"x1/4"	25	0,77
392233	8423545021187	1/2"x1/8"	25	1,19
392244	8423545021194	1/2"x1/4"	25	1,13
392201	8423545021149	1/2"x3/8"	25	1,00
392302	8423545021217	3/4"x1/2"	25	1,18
392402	8423545021309	1"x1/2"	10	2,49
392403	8423545021316	1"x3/4"	10	2,02
392502	8423545080023	1" 1/4x1/2"	-	5,60
392503	8423545021323	1" 1/4x3/4"	-	4,31
392504	8423545042854	1" 1/4x1"	-	3,89
392602	8423545021347	1" 1/2x1/2"	-	6,49
392603	8423545021354	1" 1/2x3/4"	-	6,51
392604	8423545075913	1" 1/2x1"	-	6,60
392605	8423545021378	1" 1/2x1" 1/4	-	4,85
392702	8423545021385	2"x1/2"	-	11,63
392703	8423545021392	2"x3/4"	-	12,27
392704	8423545021408	2"x1"	-	11,07
392705	8423545021415	2"x1" 1/4	-	10,31
392706	8423545021422	2"x1" 1/2	-	8,04
392807	8423545021439	2" 1/2x2"	-	16,65
392907	8423545021446	3"x2"	-	32,79
392908	8423545021453	3"x2" 1/2	-	30,51
392957	8423545079881	4"x2"	-	88,00
392958	8423545079874	4"x2" 1/2	-	82,00
392959	8423545079867	4"x3"	-	85,10

**Chromé / Chromium-plated / Cromado**

CÓDIGO	CÓDIGO EAN	ARTÍCULO	BOLSA	PRECIO (€)
392211	8423545021163	1/2"x3/8"	25	1,40
392312	8423545021231	3/4"x1/2"	25	1,58

**Economique / Economic / Económico**

CÓDIGO	CÓDIGO EAN	ARTÍCULO	BOLSA	PRECIO (€)
392221	8423545105801	1/2"x3/8"	25	0,71
392322	8423545105818	3/4"x1/2"	25	1,10
392423	8423545105825	1"x3/4"	10	1,66
392524	8423545129937	1" 1/4x1"	-	3,30

Disponibile en acabado NIQUELADO bajo pedido  
Available in NICKLELED finition by order / Disponible en finition NIQUELE sous commande

Racorería de Latón para Roscar / Screw Brass Fittings / Raccords Laiton à Viser

Raccords Laiton à Viser / Screw Brass Fittings / Racorería de Latón para Roscar

Codo H-H (TH90) / Elbow F-F (TH90) / Coude F-F (8090)



CÓDIGO	CÓDIGO EAN	ARTÍCULO	BOLSA	PRECIO (€)
301001	8423545015469	3/8"	25	1,51
301002	8423545015476	1/2"	10	2,62
301003	8423545015490	3/4"	10	3,31
301004	8423545015513	1"	10	6,57
301005	8423545015537	1" 1/4	-	12,90
301006	8423545015544	1" 1/2	-	15,95
301007	8423545015551	2"	-	27,90
301008*	8423545015568	2" 1/2	-	73,80
301009*	8423545015575	3"	-	98,00
301000*	8423545080214	4"	-	168,00

\* Fundido / Cast / Fonte

Cromado / Chromium-plated / Chromé

CÓDIGO	CÓDIGO EAN	ARTÍCULO	BOLSA	PRECIO (€)
301011	8423545015582	3/8"	25	2,20
301012	8423545015599	1/2"	10	3,30
301013	8423545015605	3/4"	10	4,05
301014	8423545015612	1"	10	7,11

Económico / Economic / Economique

CÓDIGO	CÓDIGO EAN	ARTÍCULO	BOLSA	PRECIO (€)
301022	8423545125045	1/2"	10	1,67
301023	8423545125052	3/4"	10	2,97
301024	8423545125069	1"	10	4,69
301025	8423545136577	1" 1/4	-	*
301026	8423545136584	1" 1/2	-	*
301027	8423545136591	2"	-	*



Disponibile en acabado NIQUELADO bajo pedido  
Available in NICKELLED finition by order  
Disponibile en finition NIQUELE sous commande

\* En preparación  
In process / En course

Codo Reducido H-H (TH90/R) / Reduced Elbow F-F (TH90/R) / Coude Réduit F-F (8090/R)



CÓDIGO	CÓDIGO EAN	ARTÍCULO	BOLSA	PRECIO (€)
381203	8423545021071	1/2"x3/4"	-	3,93
381204*	8423545021088	1/2"x 1"	-	7,40
381304	8423545021095	3/4"x 1"	-	6,02

\* Fundido / Cast / Fonte

Codo Reducido M-H (TH92/R) / Reduced Elbow M-F (TH92/R) / Coude Réduit M-F (8092/R)



CÓDIGO	CÓDIGO EAN	ARTÍCULO	BOLSA	PRECIO (€)
306203*	8423545015902	1/2"x3/4"	-	4,78
306304*	8423545063712	3/4"x1"	-	8,20
306405*	8423545063729	1"x1" 1/4	-	15,87

\* Fundido / Cast / Fonte

Coude M-F (8092) / Elbow M-F (TH92) / Codo M-H (TH92)



CÓDIGO	CÓDIGO EAN	ARTÍCULO	BOLSA	PRECIO (€)
304001	8423545069899	3/8" **	25	1,35
304002	8423545069905	1/2" **	10	2,01
304003	8423545069912	3/4" **	10	3,76
304004	8423545069929	1" **	10	5,92
303005	8423545015742	1" 1/4	-	12,99
303006	8423545015759	1" 1/2	-	17,62
303007	8423545015766	2"	-	29,90
304008*	8423545069875	2" 1/2 **	-	77,40
304009*	8423545069882	3" **	-	108,00
304000*	8423545080221	4" **	-	159,90

\* Fonte / Cast / Fundido \*\*Sans Colletterette / No Ring / Sin Valona

Chromé / Chromium-plated / Cromado

CÓDIGO	CÓDIGO EAN	ARTÍCULO	BOLSA	PRECIO (€)
304011	8423545070055	3/8" **	25	1,95
304012	8423545070062	1/2" **	10	2,73
304013	8423545070079	3/4" **	10	4,24
304014	8423545070086	1" **	10	6,64

\*\*Sans Colletterette / No Ring / Sin Valona

Economique / Economic / Económico

CÓDIGO	CÓDIGO EAN	ARTÍCULO	BOLSA	PRECIO (€)
304022	8423545125076	1/2	10	1,72
304023	8423545125083	3/4	10	2,83
304024	8423545125090	1"	10	4,59
304025	8423545136645	1" 1/4	-	*
304026	8423545136652	1" 1/2	-	*
304027	8423545136669	2"	-	*

Disponibile en acabado NIQUELADO bajo pedido  
Available in NICKELLED finition by order  
Disponibile en finition NIQUELE sous commande

\* En preparación  
In process / En course

Coude Courbe M-F / Elbow M-F Curve / Codo Curva M-H



CÓDIGO	CÓDIGO EAN	ARTÍCULO	BOLSA	PRECIO (€)
308002	8423545132623	1/2" **	25	3,09
308003	8423545132630	3/4" **	10	4,61

\*\*Sans Colletterette / No Ring / Sin Valona

Coude M-M Joint Plat (8091L) / Elbow M-M Flat Joint (TH91L) / Codo M-M Junta Plana (TH91L)



CÓDIGO	CÓDIGO EAN	ARTÍCULO	BOLSA	PRECIO (€)
307010	8423545079492	3/8x10 PLANA	-	2,70
307022	8423545015926	1/2x14 PLANA	-	2,10
307033	8423545015933	3/4x18 PLANA	-	2,65

Racorería de Latón para Roscar / Screw Brass Fittings / Raccords Laiton à Viser

Raccords Laiton à Viser / Screw Brass Fittings / Racorería de Latón para Roscar

Codo Mural (471) / Threaded Wall Elbow (471) / Applique Mural (8471)



CÓDIGO	CÓDIGO EAN	ARTÍCULO	BOLSA	PRECIO (€)
205202	8423545062289	1/2" Mx1/2"H	10	5,35
205222	8423545062869	1/2" Hx1/2"H	10	5,20

Cromado / Chromium-plated / Chromé

CÓDIGO	CÓDIGO EAN	ARTÍCULO	BOLSA	PRECIO (€)
205212	8423545087909	1/2" Mx1/2"H	10	6,25
205232	8423545090695	1/2" Hx1/2"H	10	6,18

Te H-H-H (TH130) / Tee F-F-F (TH130) / Te F-F-F (8130)



CÓDIGO	CÓDIGO EAN	ARTÍCULO	BOLSA	PRECIO (€)
321001	8423545017135	3/8"	25	2,09
321002	8423545017142	1/2"	10	3,27
321003	8423545017166	3/4"	10	4,54
321004	8423545017180	1"	-	8,19
321005	8423545017197	1" 1/4	-	15,23
321006	8423545017203	1" 1/2	-	18,06
321007	8423545017210	2"	-	33,01
321008*	8423545017227	2" 1/2	-	104,00
321009*	8423545017234	3"	-	148,00
321000*	8423545080238	4"	-	213,77

\* Fundido / Cast / Fonte

Cromado / Chromium-plated / Chromé

CÓDIGO	CÓDIGO EAN	ARTÍCULO	BOLSA	PRECIO (€)
321011	8423545017241	3/8"	25	2,88
321012	8423545017258	1/2"	10	3,99
321013	8423545017265	3/4"	10	5,26
321014	8423545017272	1"	-	9,18

Económico / Economic / Economique

CÓDIGO	CÓDIGO EAN	ARTÍCULO	BOLSA	PRECIO (€)
321022	8423545125106	1/2	10	2,45
321023	8423545125113	3/4	10	3,89
321024	8423545125120	1"	10	6,57
321025	8423545136607	1" 1/4	-	*
321026	8423545136614	1" 1/2	-	*
321027	8423545136621	2"	-	*

Disponible en acabado NIQUELADO bajo pedido  
Available in NICKLELED finition by order  
Disponible en finition NIQUELE sous commande

\* En preparación  
In process / En course

Te M-F-M (8130) / Tee M-F-M (TH130) / Te M-H-M (TH130)

CÓDIGO	CÓDIGO EAN	ARTÍCULO	BOLSA	PRECIO (€)
321092	8423545017319	1/2"	10	4,14



Te Réduite F-F-F (8130) / Reduced Tee F-F-F (TH130) / Te Reducida H-H-H (TH130)

CÓDIGO	CÓDIGO EAN	ARTÍCULO	BOLSA	PRECIO (€)
320323*	8423545017005	3/4"x1/2"x3/4"	10	4,79
320424*	8423545017012	1"x1/2"x1"	-	6,39
320434*	8423545017029	1"x3/4"x1"	-	7,20
320535	8423545017036	1" 1/4x3/4"x1" 1/4	-	16,00
320545*	8423545017043	1" 1/4x1"x1" 1/4	-	16,00
320626	8423545017050	1" 1/2x1/2"x1" 1/2	-	18,37
320636	8423545017067	1" 1/2x3/4"x1" 1/2	-	18,87
320646	8423545017074	1" 1/2x1"x1" 1/2	-	18,87
320656	8423545017081	1" 1/2x1" 1/4x1" 1/2	-	18,87
320727	8423545017098	2"x1/2"x2"	-	28,07
320737	8423545017104	2"x3/4"x2"	-	28,07
320747	8423545017111	2"x1"x2"	-	28,08
320767	8423545017128	2"x1" 1/2x2"	-	28,07
320090	8423545080245	4"x3"x4"	-	156,00

\* Matricage / Hot stamping / Estampación



Te M-M-M Joint Plat (8130LM) / Tee M-M-M Flat Joint (TH130LM) / Te M-M-M Junta Plana (TH130LM)

CÓDIGO	CÓDIGO EAN	ARTÍCULO	BOLSA	PRECIO (€)
318012	8423545058701	3/8"x12 PLANA	-	2,24
318022	8423545016886	1/2"x14 PLANA	-	2,82
318040	8423545016909	3/4"x18 PLANA	-	3,82



Racorería de Latón para Roscar / Screw Brass Fittings / Raccords Laiton à Viser

Raccords Laiton à Viser / Screw Brass Fittings / Racorería de Latón para Roscar

Manguito H-H (TH270) / Straight Coupler F-F (TH270) / Manchon Egal Sans Butée F-F (8270)



CÓDIGO	CÓDIGO EAN	ARTÍCULO	BOLSA	PRECIO (€)
341001	8423545017838	3/8"	25	1,28
341002	8423545017845	1/2"	25	1,94
341003	8423545017869	3/4"	10	2,90
341004	8423545017883	1"	10	4,29
341005	8423545017906	1" 1/4	-	6,99
341006	8423545017913	1" 1/2	-	9,05
341007	8423545017920	2"	-	13,48
341008*	8423545017937	2" 1/2	-	47,00
341009*	8423545017944	3"	-	60,60
341000*	8423545080207	4"	-	86,50

\* Fundido / Cast / Fonte

Cromado / Chromium-plated / Chromé

CÓDIGO	CÓDIGO EAN	ARTÍCULO	BOLSA	PRECIO (€)
341011	8423545017951	3/8"	25	1,82
341012	8423545017968	1/2"	25	2,47
341013	8423545017975	3/4"	10	3,53
341014	8423545017982	1"	10	5,36



Económico / Economic / Economique

CÓDIGO	CÓDIGO EAN	ARTÍCULO	BOLSA	PRECIO (€)
341022	8423545079607	1/2	25	1,47
341023	8423545129982	3/4	10	1,99
341024	8423545129999	1"	10	3,24

Disponible en acabado NIQUELADO bajo pedido  
Available in NICKELLED finition by order / Disponible en finition NIQUELE sous commande

Manguito Reducido H-H (TH240) / Reduced Coupler F-F (TH240) / Manchon Réduit Sans Butée F-F (8240)



CÓDIGO	CÓDIGO EAN	ARTÍCULO	BOLSA	PRECIO (€)
342102	8423545018002	3/8"x1/2"	25	2,03
342203	8423545018019	1/2"x3/4"	10	2,65
342304	8423545018026	3/4"x 1"	10	3,60
342405	8423545018033	1"x1" 1/4	-	6,80
342407	8423545018040	1"x2"	-	8,20
342506	8423545018057	1" 1/4x1" 1/2	-	7,82
342507	8423545018064	1" 1/4x2"	-	8,48
342607	8423545018071	1" 1/2x 2"	-	9,61

Bouchon Mâle (8290) / Male Plug (TH290) / Tapón Macho (TH290)



CÓDIGO	CÓDIGO EAN	ARTÍCULO	BOLSA	PRECIO (€)
361333	8423545020203	1/8"	25	0,94
361444	8423545020210	1/4"	25	0,97
361001	8423545020043	3/8"	25	0,69
361002	8423545020067	1/2"	25	0,88
361003	8423545075418	3/4"	25	1,46
361004	8423545020104	1"	10	2,26
361005	8423545020128	1" 1/4	-	3,92
361006	8423545020135	1" 1/2	-	5,45
361007	8423545020142	2"	-	8,36
361000	8423545080252	4"	-	94,30

Chromé / Chromium-plated / Cromado

CÓDIGO	CÓDIGO EAN	ARTÍCULO	BOLSA	PRECIO (€)
361011	8423545020166	3/8"	25	1,02
361012	8423545020173	1/2"	25	1,18
361013	8423545020180	3/4"	25	1,82
361014	8423545020197	1"	10	2,70

Economique / Economic / Económico

CÓDIGO	CÓDIGO EAN	ARTÍCULO	BOLSA	PRECIO (€)
361022	8423545129944	1/2	25	0,78
361023	8423545129951	3/4	25	1,15
361024	8423545129968	1"	10	1,97
361025	8423545129975	1" 1/4	-	3,41

Disponible en acabado NIQUELADO bajo pedido  
Available in NICKELLED finition by order / Disponible en finition NIQUELE sous commande

Bouchon Mâle avec Scellée pour Gaz / Squarehead Male Plug with Seal for Gas / Tapón Macho con Precinto para Gas



CÓDIGO	CÓDIGO EAN	ARTÍCULO	BOLSA	PRECIO (€)
364002	8423545060469	1/2"	25	1,44
364003	8423545078990	3/4"	25	1,88
364004	8423545079157	1"	10	2,85
364078	8423545079003	7/8"	10	2,49

Racorería de Latón para Roscar / Screw Brass Fittings / Raccords Laiton à Viser

Raccords Laiton à Viser / Screw Brass Fittings / Racorería de Latón para Roscar

Tapón Hembra (TH300) / Female Plug (TH300) / Bouchon Femelle (8300)



CÓDIGO	CÓDIGO EAN	ARTÍCULO	BOLSA	PRECIO (€)
362333	8423545020388	1/8"	25	1,02
362444	8423545020395	1/4"	25	0,97
362001	8423545020227	3/8"	25	0,58
362002	8423545020241	1/2"	25	0,73
362003	8423545020265	3/4"	25	1,14
362004	8423545020289	1"	10	2,19
362005	8423545020302	1" 1/4	-	3,48
362006	8423545020319	1" 1/2	-	5,23
362007	8423545020326	2"	-	8,80
362008	8423545079140	2" 1/2	-	15,99
362009	8423545093986	3"	-	27,80
362000	8423545080269	4"	-	44,50

Cromado / Chromium-plated / Chromé

CÓDIGO	CÓDIGO EAN	ARTÍCULO	BOLSA	PRECIO (€)
362033	8423545020364	1/8"	25	1,42
362044	8423545020371	1/4"	25	1,37
362011	8423545020333	3/8"	25	0,98
362012	8423545020340	1/2"	25	1,13
362013	8423545020357	3/4"	25	1,54

Tapón Hembra con Precinto para Gas / Squarehead Female Plug with Seal for Gas / Bouchon Femelle avec Scellée pour Gaz



CÓDIGO	CÓDIGO EAN	ARTÍCULO	BOLSA	PRECIO (€)
364102	8423545079041	1/2"	25	1,30
364103	8423545079058	3/4"	25	1,73
364104	8423545079164	1"	10	2,65
364178	8423545079065	7/8"	10	2,92

Unión 3/P M-M (TH342) / 3/P Straight Union Coupler M-M (TH342) / Union Conique 3/P M-M (8342)



CÓDIGO	CÓDIGO EAN	ARTÍCULO	BOLSA	PRECIO (€)
327003	8423545130407	3/4"	-	10,82

Union Conique M-F 3/P (8341) / 3/P Straight Union Coupler M-F (TH341) / Unión 3/P M-H (TH341)

CÓDIGO	CÓDIGO EAN	ARTÍCULO	BOLSA	PRECIO (€)
326002	8423545017715	1/2"	10	6,40
326003	8423545017722	3/4"	-	10,32
326004	8423545017739	1"	-	14,60
326005	8423545017746	1" 1/4	-	23,35
326006	8423545017753	1" 1/2	-	30,00
326007	8423545017760	2"	-	47,29



Union Conique F-F 3/P (8340) / 3/P Straight Union Coupler F-F (TH340) / Unión 3/P H-H (TH340)

CÓDIGO	CÓDIGO EAN	ARTÍCULO	BOLSA	PRECIO (€)
325002	8423545017500	1/2"	10	6,24
325003	8423545017524	3/4"	-	9,53
325004	8423545017548	1"	-	13,26
325005	8423545017562	1" 1/4	-	22,35
325006	8423545017579	1" 1/2	-	28,25
325007	8423545017586	2"	-	44,78



Raccord avec Ecrou pour Réservoir d'Eau / Fitting with Nut for Water Tank / Cuerpo Racor Uralita con Tuerca

CÓDIGO	CÓDIGO EAN	ARTÍCULO	BOLSA	PRECIO (€)
349001	8423545018255	3/8"	-	2,43
349002	8423545018262	1/2"	-	3,30
349003	8423545018279	3/4"	-	4,55
349004	8423545018286	1"	-	5,99
349005	8423545063736	1" 1/4	-	8,90
349006	8423545063743	1" 1/2	-	14,50
349007	8423545063750	2"	-	27,20
349008	8423545063767	2" 1/2	-	45,08
349009	8423545063774	3"	-	84,76



Raccord pour Réservoir d'Eau / Fitting for Water Tank / Cuerpo Racor Uralita

CÓDIGO	CÓDIGO EAN	ARTÍCULO	BOLSA	PRECIO (€)
347001	8423545018217	3/8"	-	1,87
347002	8423545018224	1/2"	-	2,65
347003	8423545018231	3/4"	-	3,55
347004	8423545018248	1"	-	4,82
347005	8423545063781	1" 1/4	-	6,80
347006	8423545063798	1" 1/2	-	11,70
347007	8423545063804	2"	-	18,60
347008	8423545063811	2" 1/2	-	31,48
347009	8423545063828	3"	-	67,77



Racorería de Latón para Roscar / Screw Brass Fittings / Raccords Laiton à Viser

Raccords Laiton à Viser / Screw Brass Fittings / Racorería de Latón para Roscar

Arandela de Hierro / Iron Washer / Rondelle Fer



CÓDIGO	CÓDIGO EAN	ARTÍCULO	BOLSA	PRECIO (€)
958001	8423545056868	3/8"	100	0,16
958002	8423545056875	1/2"	100	0,19
958003	8423545056882	3/4"	100	0,26
958004	8423545056899	1"	100	0,36
958005	8423545056905	1" 1/4	100	0,52
958006	8423545056912	1" 1/2	100	0,68
958007	8423545056929	2"	50	0,87

Arandela de Latón / Brass Washer / Rondelle Laiton



CÓDIGO	CÓDIGO EAN	ARTÍCULO	BOLSA	PRECIO (€)
958101	8423545056936	3/8"	100	0,67
958102	8423545056943	1/2"	100	0,72
958103	8423545056950	3/4"	100	0,99
958104	8423545056967	1"	100	1,11
958105	8423545056974	1" 1/4	100	2,83
958106	8423545056981	1" 1/2	100	2,99
958107	8423545056998	2"	50	4,55

Racor Contador con Junta / Meter Set with Seal / Raccord Compteur avec Scellée



CÓDIGO	CÓDIGO EAN	ARTÍCULO	BOLSA	PRECIO (€)
445502	8423545022559	1/2"x1/2"	25	4,12
445555	8423545086148	5/8"x1/2"	25	4,55
445503	8423545022566	3/4"x1/2"	25	3,75
445578	8423545022580	7/8"x1/2"	25	4,62
445504	8423545068793	1"x3/4"	10	5,65
445505	8423545083345	1" 1/4x1"	-	8,70
445506	8423545083352	1" 1/2x1" 1/4	-	14,92
445507	8423545083369	2"x1" 1/2	-	19,62
445508	8423545086117	2" 1/2x2"	-	37,60
445100	8423545022481	CONJUNTO RACOR CONTADOR 7/8"x1/2" - 3/4"x1/2"	-	8,65

Réduction Lisse M-F / Reducer Threaded M-F / Reducción Lisa M-H

CÓDIGO	CÓDIGO EAN	ARTÍCULO	BOLSA	PRECIO (€)
396441	8423545021552	3/8"x1/4"	25	0,87
396201	8423545021507	1/2"x3/8"	25	1,10
396302	8423545021521	3/4"x1/2"	25	1,28



Chromé / Chromium-plated / Cromado

CÓDIGO	CÓDIGO EAN	ARTÍCULO	BOLSA	PRECIO (€)
396211	8423545021514	1/2"x3/8"	25	1,40
396312	8423545021538	3/4"x1/2"	25	1,58

Ecrou Laiton pour Raccord 2p. / Brass Nut for 2p. Fitting / Tuerca Latón para Racor 2p.

CÓDIGO	CÓDIGO EAN	ARTÍCULO	BOLSA	PRECIO (€)
442110	8423545022009	3/8"x10 mm.	-	0,60
442210	8423545022023	1/2"x10,5 mm.	-	0,85
442212	8423545022030	1/2"x12,5 mm.	-	0,71
442214	8423545022054	1/2"x14,5 mm.	-	0,71
442321	8423545022139	3/4"x21,5 mm.	-	1,20
442422	8423545064573	1"x22 mm.	-	1,80
442426	8423545022177	1"x26,5 mm.	-	1,75
442531	8423545022191	1" 1/4x31 mm.	-	3,20
442642	8423545022238	1" 1/2x42,5 mm.	-	3,78
442750	8423545022269	2"x50,8 mm.	-	6,85
442863	8423545022283	2" 1/2x63,5 mm.	-	14,00
442976	8423545022290	3"x76mm.	-	28,00



Chromé / Chromium-plated / Cromado

CÓDIGO	CÓDIGO EAN	ARTÍCULO	BOLSA	PRECIO (€)
443110	8423545022306	3/8"x10 mm	-	0,87
443210	8423545022313	1/2"x10 mm	-	1,12
443212	8423545022320	1/2"x12 mm	-	1,12
443214	8423545022337	1/2"x14 mm	-	1,12
443321	8423545022351	3/4"x21 mm	-	1,52

Racorería de Latón para Roscar / Screw Brass Fittings / Raccords Laiton à Viser

Raccords Laiton à Viser / Screw Brass Fittings / Racorería de Latón para Roscar

**Alargo M-H Pulido (TH526) / Polished Extension Piece M-F (TH526) / Allonge Lisse Polie M-F (8526)**



CÓDIGO	CÓDIGO EAN	ARTÍCULO	BOLSA	PRECIO (€)
375103	8423545020647	3/8"x3 cm	5	3,23
375105	8423545020654	3/8"x5 cm	-	4,56
375110	8423545020678	3/8"x10 cm	-	7,57
375202	8423545020685	1/2"x2 cm	5	2,60
375203	8423545075920	1/2"x3 cm	5	3,40
375204	8423545020708	1/2"x4 cm	5	3,59
375205	8423545020715	1/2"x5 cm	5	4,98
375206	8423545020722	1/2"x6 cm	-	5,95
375207	8423545020739	1/2"x 7 cm	-	6,50
375208	8423545020746	1/2"x8 cm	5	7,24
375210	8423545020753	1/2"x10 cm	5	9,54
375305	8423545020777	3/4"x5 cm	5	8,32
375308	8423545020784	3/4"x8 cm	-	10,58
375310	8423545020791	3/4"x10 cm	-	11,99

**Alargo M-H Cromado (TH526) / Chromium-plated Extension Piece M-F (TH526) / Allonge Lisse Chromé M-F (8526)**



CÓDIGO	CÓDIGO EAN	ARTÍCULO	BOLSA	PRECIO (€)
376103	8423545020807	3/8"x3 cm	5	3,62
376105	8423545020814	3/8"x5 cm	-	4,82
376110	8423545020838	3/8"x10 cm	-	8,47
376202	8423545020845	1/2"x2 cm	-	2,99
376203	8423545020852	1/2"x3 cm	5	3,79
376204	8423545020869	1/2"x4 cm	5	4,10
376205	8423545020876	1/2"x5 cm	5	5,37
376206	8423545020883	1/2"x6 cm	5	6,34
376207	8423545020890	1/2"x7 cm	5	6,95
376208	8423545020906	1/2"x8 cm	5	7,63
376210	8423545020913	1/2"x10 cm	-	10,44
376305	8423545020937	3/4"x5 cm	5	8,71
376308	8423545020944	3/4"x8 cm	-	11,48
376310	8423545020951	3/4"x10 cm	-	12,89

**Contre-écrou à Plateau / Slide Nut with Flange / Tuerca Corredera con Valona**

CÓDIGO	CÓDIGO EAN	ARTÍCULO	BOLSA	PRECIO (€)
371001	8423545020470	3/8"	100	0,56
371002	8423545020487	1/2"	50	0,65
371003	8423545020494	3/4"	50	0,91
371004	8423545020500	1"	25	1,11
371005	8423545020517	1" 1/4	25	1,85
371006	8423545062579	1" 1/2	25	2,80
371007	8423545020531	2"	-	7,99
371008*	8423545020548	2" 1/2	-	13,60
371009*	8423545020555	3"	-	16,99

\* Fonte / Cast / Fundido



**Distributeur 3 Voies F (8221) / 3 Ways Elbow (TH221) / Codo 3 Bocas (TH221)**

CÓDIGO	CÓDIGO EAN	ARTÍCULO	BOLSA	PRECIO (€)
304222*	8423545015889	1/2"	-	8,40
304333*	8423545015896	3/4"	-	10,80

\* Fonte / Cast / Fundido



**Distributeur 4 Voies F (8180) / 4 Ways F Cross (TH180) / Cruz 4 Bocas H (TH180)**

CÓDIGO	CÓDIGO EAN	ARTÍCULO	BOLSA	PRECIO (€)
324002*	8423545017449	1/2"	-	6,80
324003*	8423545017456	3/4"	-	7,86
324004	8423545017463	1"	-	17,33
324005	8423545017470	1" 1/4	-	24,87
324006	8423545017487	1" 1/2	-	33,94
324007	8423545017494	2"	-	44,00

\* Matricage / Hot stamping / Estampación



**Courbe 90° M-F (TH1) / 90° M-F Curve (TH1) / Curva 90° M-H (TH1)**

CÓDIGO	CÓDIGO EAN	ARTÍCULO	BOLSA	PRECIO (€)
323002*	8423545017388	1/2"	-	6,80
323003	8423545017395	3/4"	-	10,93
323004	8423545017401	1"	-	14,33
323005	8423545017418	1" 1/4	-	24,00
323006	8423545017425	1" 1/2	-	30,81
323007	8423545017432	2"	-	55,41

\* Matricage / Hot stamping / Estampación



Racorería de Latón para Roscar / Screw Brass Fittings / Raccords Laiton à Viser

Raccords Laiton à Viser / Screw Brass Fittings / Racorería de Latón para Roscar

Curva 90° H-H (TH2) / 90° F-F Curve (TH2) / Courbe 90° F-F (TH2)



CÓDIGO	CÓDIGO EAN	ARTÍCULO	BOLSA	PRECIO (€)
322002*	8423545017326	1/2"	-	7,50
322003	8423545017333	3/4"	-	10,93
322004	8423545017340	1"	-	14,33
322005	8423545017357	1" 1/4	-	24,00
322006	8423545017364	1" 1/2	-	30,81
322007	8423545017371	2"	-	55,41
322008	8423545084762	2" 1/2	-	108,75
322009	8423545084779	3"	-	167,99

\* Estampación / Hot stamping / Matricage

Collarín Toma con Junta / Intake Collet with Joint / Collier Prise Rapide d'Eau avec Joint



CÓDIGO	CÓDIGO EAN	ARTÍCULO	BOLSA	PRECIO (€)
959220*	8423545057025	20x1/2"	-	7,01
959225*	8423545057049	25x1/2"	-	7,41
959232*	8423545057063	32x1/2"	-	10,29
959240*	8423545057087	40x1/2"	-	13,99
959250	8423545057094	50x1/2"	-	24,95
959263	8423545057100	63x1/2"	-	31,48
959275	8423545057117	75x1/2"	-	43,70
959290	8423545057124	90x1/2"	-	63,15
959340*	8423545057131	40x3/4"	-	14,32
959350	8423545057148	50x3/4"	-	25,75
959363	8423545057155	63x3/4"	-	28,68
959375	8423545057162	75x3/4"	-	41,01
959390	8423545057179	90x3/4"	-	65,14
959463	8423545057186	63x1"	-	29,81
959475	8423545057193	75x1"	-	46,68
959490	8423545057209	90x1"	-	64,59

\* Estampación / Hot stamping / Matricage

Collarín Ciego con Junta / Intake Blind Collet with Joint / Collier Prise Aveugle d'Eau avec Joint



CÓDIGO	CÓDIGO EAN	ARTÍCULO	BOLSA	PRECIO (€)
972220*	8423545057599	20	-	6,35
972325*	8423545057612	25	-	7,15
972432*	8423545057636	32	-	9,93
972540*	8423545057650	40	-	13,37
972650	8423545057667	50	-	24,00
972763	8423545057674	63	-	28,00
972875	8423545057681	75	-	34,50
972990	8423545057698	90	-	78,60

\* Estampación / Hot stamping / Matricage

Collier Prise Rapide d'Eau 4 Ancres avec Joint / 4 Anchors Intake Collet with Joint / Collarín Toma 4 Anclajes con Junta



CÓDIGO	CÓDIGO EAN	ARTÍCULO	BOLSA	PRECIO (€)
959002	8423545087374	20x1/2"	-	10,31

Manchon Electrolytic / Electrolytic Coupler / Manguito Electrolítico



CÓDIGO	CÓDIGO EAN	ARTÍCULO	BOLSA	PRECIO (€)
241002	8423545013502	1/2"	25	3,20
241003	8423545013526	3/4"	20	4,10
241004	8423545013540	1"	20	6,19
241005	8423545013557	1" 1/4	12	21,58
241006	8423545013564	1" 1/2	8	31,65
241007	8423545013571	2"	2	46,16
241008	8423545013588	2" 1/2	-	80,95
241009	8423545013595	3"	-	133,64

Racorería de Latón para Roscar / Screw Brass Fittings / Raccords Laiton à Viser

Raccords Laiton à Viser / Screw Brass Fittings / Racorería de Latón para Roscar

Nipple de Hierro Galvanizado / Galvanized Iron Nipple / Nipple Fer Galvanisé



CÓDIGO	CÓDIGO EAN	ARTÍCULO	BOLSA	PRECIO (€)
682040	8423545037447	1/2"x40 mm	10	1,56
682060	8423545037454	1/2"x60 mm	10	1,91
682080	8423545037461	1/2"x80 mm	10	2,28
682100	8423545037478	1/2"x100 mm	10	2,86
682120	8423545037485	1/2"x120 mm	10	3,26
682140	8423545037492	1/2"x140 mm	10	3,65
682160	8423545037508	1/2"x160 mm	10	4,26
682180	8423545037515	1/2"x180 mm	10	4,60
682200	8423545037522	1/2"x200 mm	10	5,04
683040	8423545037577	3/4"x40 mm	10	1,84
683060	8423545037584	3/4"x60 mm	10	2,28
683080	8423545037591	3/4"x80 mm	10	2,83
683100	8423545037607	3/4"x100 mm	10	3,39
683120	8423545037614	3/4"x120 mm	10	3,84
683140	8423545037621	3/4"x140 mm	10	4,75
683160	8423545037638	3/4"x160 mm	10	5,04
683180	8423545037645	3/4"x180 mm	10	4,35
683200	8423545037652	3/4"x200 mm	10	6,11
684040	8423545037706	1"x 40 mm	10	2,53
684060	8423545037713	1"x 60 mm	10	3,26
684080	8423545037720	1"x 80 mm	10	4,00
684100	8423545037737	1"x100 mm	10	4,77
684120	8423545037744	1"x120 mm	10	5,65
684140	8423545037751	1"x140 mm	10	6,43
684160	8423545037768	1"x160 mm	10	7,28
684180	8423545037775	1"x180 mm	10	7,96
684200	8423545037782	1"x200 mm	10	8,77
685060	8423545037843	1" 1/4x60 mm	5	4,82
685080	8423545037850	1" 1/4x80 mm	5	5,57
685100	8423545037867	1" 1/4x100 mm	5	6,03
685120	8423545037874	1" 1/4x120 mm	5	7,13
685140	8423545037881	1" 1/4x140 mm	5	7,98
685160	8423545037898	1" 1/4x160 mm	5	9,23
685180	8423545037904	1" 1/4x180 mm	5	9,55

Nipple Fer Galvanisé / Galvanized Iron Nipple / Nipple de Hierro Galvanizado



CÓDIGO	CÓDIGO EAN	ARTÍCULO	BOLSA	PRECIO (€)
685200	8423545037991	1" 1/4x200 mm	5	10,95
686060	8423545037966	1" 1/2x 60 mm	5	5,61
686080	8423545037973	1" 1/2x80 mm	5	6,60
686100	8423545037980	1" 1/2x100 mm	5	7,11
686120	8423545037997	1" 1/2x120 mm	5	9,12
686140	8423545038000	1" 1/2x140 mm	5	10,24
686160	8423545038017	1" 1/2x160 mm	5	10,73
686180	8423545038024	1" 1/2x180 mm	5	12,09
686200	8423545038031	1" 1/2x200 mm	5	13,59
687060	8423545038086	2"x 60 mm	5	6,89
687080	8423545038093	2"x 80 mm	5	7,98
687100	8423545038109	2"x100 mm	5	9,46
687120	8423545038116	2"x120 mm	5	11,10
687140	8423545038123	2"x140 mm	5	12,62
687160	8423545038130	2"x160 mm	5	14,30
687180	8423545038147	2"x180 mm	5	15,79
687200	8423545038154	2"x200 mm	5	17,36

Raccords Laiton à Souder / Soldering Brass Fittings / Racorería de Latón para Soldar

Coude Mâle 8092 GCu / Male Elbow 92 GCu / Codo Macho 92 GCu



CÓDIGO	CÓDIGO EAN	ARTÍCULO	BOLSA	PRECIO (€)
206110*	8423545069936	3/8"x10	25	1,81
206112*	8423545069943	3/8"x12	25	1,69
206114*	8423545069981	3/8"x14	25	1,47
206115*	8423545069967	3/8"x15	25	1,45
206212*	8423545069974	1/2"x12	25	1,66
206214*	8423545069998	1/2"x14	25	1,69
206215*	8423545070000	1/2"x15	25	1,66
206216*	8423545070017	1/2"x16	25	2,07
206218*	8423545070024	1/2"x18	25	1,90
206222*	8423545079393	1/2"x22	10	2,47
206318*	8423545070031	3/4"x18	10	2,11
206322*	8423545070048	3/4"x22	10	3,20
203428	8423545012352	1"x28	10	5,90
203535**	8423545012369	1" 1/4x35	-	13,50
203642**	8423545012376	1" 1/2x42	-	68,50
203754**	8423545012383	2"x54	-	35,60

\* Sans Colerette / No Flange / Sin Valona  
 \*\* Fonte / Cast / Fundido

Racorera de Latn para Soldar / Soldering Brass Fittings / Raccords Laiton à Souder

Raccords Laiton à Souder / Soldering Brass Fittings / Racoreria de Latn para Soldar

Codo Hembra 90 GCu / Female Elbow 90 GCu / Coude Femelle 8090 GCu



CÓDIGO	CÓDIGO EAN	ARTÍCULO	BOLSA	PRECIO (€)
201110	8423545011829	3/8"x10	25	1,80
201112	8423545011836	3/8"x12	25	1,10
201114	8423545011843	3/8"x14	25	1,40
201115	8423545011850	3/8"x15	25	1,40
201210	8423545011867	1/2"x10	25	2,10
201212	8423545011874	1/2"x12	25	1,59
201214	8423545011881	1/2"x14	25	1,56
201215	8423545075906	1/2"x15	25	1,53
201216	8423545011928	1/2"x16	25	1,71
201218	8423545011942	1/2"x18	25	1,88
201222	8423545011966	1/2"x22	10	2,39
201314	8423545012000	3/4"x14	10	2,78
201315	8423545012017	3/4"x15	10	2,69
201316	8423545012024	3/4"x16	10	2,53
201318	8423545012031	3/4"x18	10	2,59
201322	8423545012062	3/4"x22	10	3,03
201328	8423545012079	3/4"x28	10	4,30
201422	8423545012086	1"x22	10	4,88
201428	8423545012093	1"x28	10	6,68
201528*	8423545012109	1" 1/4x28	-	12,40
201535*	8423545012116	1" 1/4x35	-	13,50
201642*	8423545012123	1" 1/2x42	-	21,50
201754*	8423545012130	2"x54	-	30,50

\* Fundido / Cast / Fonte

Económico / Economic / Economique

CÓDIGO	CÓDIGO EAN	ARTÍCULO	BOLSA	PRECIO (€)
201225	8423545062357	1/2"x15	25	1,49

Disponibile en acabado NIQUELADO bajo pedido  
Available in NICKELLED finition by order / Disponible en finition NIQUELE sous commande

Codo Hembra Largo 90 GICu / Long Female Elbow 90 GICu / Coude Femelle Long 8090 GICu



CÓDIGO	CÓDIGO EAN	ARTÍCULO	BOLSA	PRECIO (€)
202212	8423545012147	1/2"x12	25	2,76
202214	8423545012154	1/2"x14	25	2,88
202215	8423545012161	1/2"x15	25	3,18
202216	8423545012178	1/2"x16	25	3,19

Applique Mural 8472 GCu / Wall Elbow 472 GCu / Codo Mural 472 GCu



CÓDIGO	CÓDIGO EAN	ARTÍCULO	BOLSA	PRECIO (€)
204212	8423545012390	1/2"x12	25	2,73
204214	8423545012413	1/2"x14	25	2,70
204215	8423545012437	1/2"x15	25	2,70
205215*	8423545061763	1/2"x15 REFORZADO	10	3,67
204216	8423545012451	1/2"x16	25	3,13
204218	8423545012475	1/2"x18	10	3,93
204318	8423545083482	3/4"x18	10	5,49
204322	8423545012499	3/4"x22	10	5,19
204428**	8423545012505	1"x28	-	12,80

\* Renforcé / Reinforced / Reforzado

\*\* Fonte / Cast / Fundido

Manchon Femelle 8270 GCu / Female Coupler 270 GCu / Enlace Hembra 270 GCu



CÓDIGO	CÓDIGO EAN	ARTÍCULO	BOLSA	PRECIO (€)
231110	8423545013205	3/8"x10	25	0,87
231112	8423545013212	3/8"x12	25	0,69
231114	8423545013229	3/8"x14	25	0,81
231115	8423545013236	3/8"x15	25	0,91
231210	8423545013243	1/2"x10	25	1,07
231212	8423545013250	1/2"x12	25	0,94
231214	8423545013274	1/2"x14	25	0,98
231215	8423545013298	1/2"x15	25	1,04
231216	8423545013311	1/2"x16	25	1,08
231218	8423545013328	1/2"x18	25	1,19
231222	8423545013359	1/2"x22	25	1,89
231314	8423545013373	3/4"x14	25	2,04
231315	8423545013380	3/4"x15	25	1,91
231316	8423545013397	3/4"x16	25	1,99
231318	8423545013403	3/4"x18	25	1,69
231322	8423545013427	3/4"x22	25	1,85
231328	8423545013434	3/4"x28	10	2,99
231422	8423545013441	1"x22	10	2,73
231428	8423545013458	1"x28	10	2,94
231528	8423545013465	1" 1/4x28	-	7,70
231535	8423545013472	1" 1/4x35	-	7,12
231642	8423545013489	1" 1/2x42	-	8,55
231754	8423545013496	2"x54	-	14,60

Economique / Economic / Económico

CÓDIGO	CÓDIGO EAN	ARTÍCULO	BOLSA	PRECIO (€)
231225	8423545068724	1/2"x15	25	0,83

Racorería de Latón para Soldar / Soldering Brass Fittings / Raccords Laiton à Souder

Raccords Laiton à Souder / Soldering Brass Fittings / Racorería de Latón para Soldar

Entronque Soldar Macho 243 GCu / Male Coupler 243 GCu / Manchon Mâle 8243 GCu



CÓDIGO	CÓDIGO EAN	ARTÍCULO	BOLSA	PRECIO (€)
211110	8423545012512	3/8"x10	25	0,83
211112	8423545012529	3/8"x12	25	0,76
211114	8423545012536	3/8"x14	25	0,92
211115	8423545012550	3/8"x15	25	0,69
211210	8423545012574	1/2"x10	25	1,17
211212	8423545012581	1/2"x12	25	1,01
211214	8423545012598	1/2"x14	25	1,01
211215	8423545011904	1/2"x15	25	1,01
211216	8423545012635	1/2"x16	25	1,03
211218	8423545012659	1/2"x18	25	1,11
211222	8423545012680	1/2"x22	25	1,55
211314	8423545012703	3/4"x14	25	1,75
211315	8423545012710	3/4"x15	25	1,81
211316	8423545012727	3/4"x16	25	2,02
211318	8423545012734	3/4"x18	25	1,85
211322	8423545012765	3/4"x22	25	1,73
211328	8423545012772	3/4"x28	10	2,87
211422	8423545012789	1"x22	10	2,79
211428	8423545012796	1"x28	10	2,92
211435	8423545012819	1"x35	-	4,86
211528	8423545012826	1" 1/4x28	-	5,90
211535	8423545012840	1" 1/4x35	-	5,12
211542	8423545012864	1" 1/4x42	-	6,19
211635	8423545012888	1" 1/2x35	-	6,29
211642	8423545012918	1" 1/2x42	-	5,76
211754	8423545012932	2"x54	-	9,99
211864	8423545076323	2" 1/2x64	-	30,21
211867	8423545076330	2" 1/2x66,7	-	31,16
211976	8423545076347	3"x76	-	37,21
211979	8423545076354	3"x79,4	-	39,75
211994	8423545076361	4"x104	-	115,75
211996	8423545076378	4"x106	-	118,30
211998	8423545090725	4"x108	-	120,84

Económico / Economic / Economique

CÓDIGO	CÓDIGO EAN	ARTÍCULO	BOLSA	PRECIO (€)
211225	8423545064474	1/2"x15	25	0,85
211228	8423545064504	1/2"x18	25	0,88

Disponibile en acabado NIQUELADO bajo pedido / Available in NICKELLED finition by order / Disponible en finition NIQUELE sous commande

Joint Plat / Flat Joint / Junta Plana

CÓDIGO	CÓDIGO EAN	ARTÍCULO	BOLSA	PRECIO (€)
211110F	8423545090749	3/8"x10	10	0,92
211112F	8423545059906	3/8"x12	10	0,90
211114F	8423545059425	3/8"x14	10	0,90
211210F	8423545084434	1/2"x10	10	1,55
211212F	8423545058954	1/2"x12	10	1,48
211214F	8423545058749	1/2"x14	10	1,16
211216F	8423545059104	1/2"x16	10	1,16
211218F	8423545060223	1/2"x18	10	1,49
211318F	8423545060230	3/4"x18	10	2,06
211320F	8423545060247	3/4"x20	10	2,10
211322F	8423545060254	3/4"x22	10	1,85
211422F	8423545060261	1"x22	10	3,30
211428F	8423545060278	1"x28	10	3,38

Te Femelle 8130 GCu / Female Tee 130 GCu / Te Hembra 130 GCu

CÓDIGO	CÓDIGO EAN	ARTÍCULO	BOLSA	PRECIO (€)
221112	8423545012949	3/8"x12	25	1,99
221114	8423545012956	3/8"x14	25	1,83
221115	8423545012963	3/8"x15	25	1,79
221212	8423545012970	1/2"x12	25	2,33
221214	8423545012994	1/2"x14	25	2,01
221215	8423545013014	1/2"x15	25	2,02
221216	8423545013038	1/2"x16	25	2,33
221218	8423545013052	1/2"x18	25	2,60
221222	8423545013076	1/2"x22	10	3,11
221318	8423545013090	3/4"x18	10	3,52
221322	8423545013113	3/4"x22	10	4,77
221328	8423545013120	3/4"x28	10	7,22
221422	8423545013137	1"x22	10	6,45
221428	8423545013144	1"x28	10	8,59
221535	8423545013151	1" 1/4x35	-	15,26
221642	8423545013168	1" 1/2x42	-	25,12
221754	8423545013175	2"x54	-	43,88



Racorería de Latón para Soldar / Soldering Brass Fittings / Raccords Laiton à Souder

Raccords Laiton à Souder / Soldering Brass Fittings / Racorería de Latón para Soldar

Tapón Latón Soldar 310 GCu / Soldering Plug 310 GCu / Bouchon à Souder 8310 GCu



CÓDIGO	CÓDIGO EAN	ARTÍCULO	BOLSA	PRECIO (€)
261012	8423545014622	12 mm	25	0,67
261014	8423545014646	14 mm	25	0,89
261015	8423545014660	15 mm	25	0,97
261016	8423545014684	16 mm	25	0,97
261018	8423545014707	18 mm	25	1,15
261022	8423545014721	22 mm	25	1,84

Curva Desviación Soldar 85 GCu / Soldering Curve 85 GCu / Courbe à Souder 8085 GCu



CÓDIGO	CÓDIGO EAN	ARTÍCULO	BOLSA	PRECIO (€)
260015	8423545014592	15 mm	-	6,58
260018	8423545014608	18 mm	-	7,60
260022	8423545014615	22 mm	-	10,99

Cruz Fundida Soldar 180 GCu / Soldering Cross 180 GCu / Croix à Souder 8180 GCu



CÓDIGO	CÓDIGO EAN	ARTÍCULO	BOLSA	PRECIO (€)
270015	8423545014752	15 mm	-	2,40
270018	8423545014776	18 mm	-	5,80
270022	8423545014783	22 mm	-	9,80
270028	8423545014790	28 mm	-	15,40
270035	8423545014796	35 mm	-	18,20
270042	8423545014813	42 mm	-	29,99
270054	8423545014820	54 mm	-	40,99

Enlace Hembra Soldar 3/P 340 GCu / 3/P Soldering Female Union Coupler 340 GCu / Union 3/P Femelle à Souder 8340 GCu



CÓDIGO	CÓDIGO EAN	ARTÍCULO	BOLSA	PRECIO (€)
554112	8423545029886	3/8" x12	10	3,54
554114	8423545029893	3/8" x14	10	3,54
554115	8423545029909	3/8" x15	10	3,44
554212	8423545029916	1/2" x12	10	3,21
554214	8423545029930	1/2" x14	10	3,19
554215	8423545029961	1/2" x15	10	3,12
554216	8423545029992	1/2" x16	10	4,35
554218	8423545030011	1/2" x18	10	4,41
554222	8423545030035	1/2" x22	10	5,77
554314	8423545030042	3/4" x14	10	4,78
554315	8423545030059	3/4" x15	10	4,85

Union 3/P Femelle à Souder 8340 GCu / 3/P Soldering Female Union Coupler 340 GCu / Enlace Hembra Soldar 3/P 340 GCu

CÓDIGO	CÓDIGO EAN	ARTÍCULO	BOLSA	PRECIO (€)
554316	8423545030066	3/4" x16	10	4,64
554318	8423545030073	3/4" x18	10	4,63
554322	8423545030097	3/4" x22	10	6,71
554422	8423545030103	1" x22	10	7,71
554428	8423545030110	1" x28	-	13,43
554528	8423545079560	1" 1/4 x28	-	17,20
554535	8423545030127	1" 1/4 x35	-	17,10
554642	8423545030141	1" 1/2 x42	-	28,15
554754	8423545030165	2" x54	-	35,05

Union 3/P Mâle à Souder 8341 GCu / 3/P Soldering Male Union Coupler 341 GCu / Enlace Macho Soldar 3/P 341 GCu

CÓDIGO	CÓDIGO EAN	ARTÍCULO	BOLSA	PRECIO (€)
555112	8423545030509	3/8" x12	10	3,12
555114	8423545030516	3/8" x14	10	3,10
555115	8423545030523	3/8" x15	10	3,02
555212	8423545030530	1/2" x12	10	3,38
555214	8423545030554	1/2" x14	10	3,36
555215	8423545030578	1/2" x15	10	3,29
555216	8423545030592	1/2" x16	10	4,39
555218	8423545030608	1/2" x18	10	4,39
555314	8423545030615	3/4" x14	10	4,94
555315	8423545030622	3/4" x15	10	5,02
555316	8423545030639	3/4" x16	10	4,79
555318	8423545030646	3/4" x18	10	4,80
555322	8423545030653	3/4" x22	10	7,51
555422	8423545030660	1" x22	10	8,59
555428	8423545030677	1" x28	-	11,67
555528	8423545079577	1" 1/4 x28	-	16,50
555535	8423545030707	1" 1/4 x35	-	15,16
555642	8423545030745	1" 1/2 x42	-	26,94
555754	8423545030769	2" x54	-	36,12



Racorería de Latón para Soldar / Soldering Brass Fittings / Raccords Laiton à Souder

Raccords Laiton à Souder / Soldering Brass Fittings / Racorería de Latón para Soldar

Enlace 3/P Soldar 340Cu / 3/P Soldering Union Coupler 340Cu / Union 3/P Conique à Souder 8340Cu



CÓDIGO	CÓDIGO EAN	ARTÍCULO	BOLSA	PRECIO (€)
556012	8423545030875	12 mm	10	2,75
556014	8423545030882	14 mm	10	2,80
556015	8423545030899	15 mm	10	2,91
556016	8423545030905	16 mm	10	3,87
556018	8423545030912	18 mm	10	3,96
556022	8423545030929	22 mm	10	5,44
556028	8423545030936	28 mm	10	11,14
556035	8423545030943	35 mm	-	14,98
556042	8423545030950	42 mm	-	23,06
556054	8423545030967	54 mm	-	37,00

Entronque Soldar Plomo / Soldering Thread Fitting / Raccord Viser-Souder pour Plomb



CÓDIGO	CÓDIGO EAN	ARTÍCULO	BOLSA	PRECIO (€)
312002	8423545016176	1/2"	25	1,85
312003	8423545016183	3/4"	25	2,70
312004	8423545016190	1"	10	3,99
312005	8423545016206	1" 1/4	-	7,35
312006	8423545016213	1" 1/2	-	8,80

Racor Curvo 2/P 2AGCu / 2/P Soldering Curved Connector 2AGCu / Raccord Courbe 2/P à Souder 2AGCu



Sin junta / No joint / Sans joint

CÓDIGO	CÓDIGO EAN	ARTÍCULO	BOLSA	PRECIO (€)
552112	8423545029558	3/8"x12	25	2,70
552114	8423545029572	3/8"x14	25	2,74
552115	8423545067826	3/8"x15	25	2,74
552212	8423545029589	1/2"x12	25	2,62
552214	8423545029596	1/2"x14	25	2,62
552215	8423545029619	1/2"x15	25	2,59
552216	8423545029633	1/2"x16	25	2,74
552218	8423545029657	1/2"x18	25	2,97
552315	8423545029695	3/4"x15	25	4,20
552316	8423545029701	3/4"x16	25	4,20
552318	8423545029718	3/4"x18	25	4,20
552322	8423545029732	3/4"x22	25	4,51
552422	8423545029749	1"x22	10	6,77
552428	8423545029756	1"x28	10	7,83

Racor Curvo 2/P Soldar 2AGCu con Precinto

Raccord Courbe 2/P à Souder 2AGCu avec Scellée / 2/P Soldering Curved Connector 2AGCu with Seal



Sans joint / No joint / Sin junta

CÓDIGO	CÓDIGO EAN	ARTÍCULO	BOLSA	PRECIO (€)
550212	8423545064368	1/2"x12	25	3,02
550214	8423545064375	1/2"x14	25	3,02
550215	8423545029503	1/2"x15	25	2,97
550216	8423545029510	1/2"x16	25	3,16
550218	8423545058855	1/2"x18	25	3,37
550315	8423545058848	3/4"x15	25	4,61
550318	8423545029534	3/4"x18	25	4,61
550322	8423545029541	3/4"x22	25	4,78
550422	8423545064719	1"x22	10	7,17

Racor Curvo 2/P 2AGCu Junta Plana

Raccord Courbe 2/P à Souder 2AGCu Joint Plat / 2/P Soldering Curved Connector 2AGCu Flat Joint



Sans joint / No joint / Sin junta

CÓDIGO	CÓDIGO EAN	ARTÍCULO	BOLSA	PRECIO (€)
553112	8423545029770	3/8"x12	10	2,55
553114	8423545029787	3/8"x14	10	2,58
553212	8423545029794	1/2"x12	10	2,74
553214	8423545029800	1/2"x14	10	2,62
553215	8423545064153	1/2"x15	10	2,59
553216	8423545029817	1/2"x16	10	2,74
553218	8423545059210	1/2"x18	10	2,96
553315	8423545067253	3/4"x15	10	4,20
553316	8423545029831	3/4"x16	10	4,20
553318	8423545029848	3/4"x18	10	4,20
553322	8423545029855	3/4"x22	10	4,51
553422	8423545029862	1"x22	10	6,45
553428	8423545029879	1"x28	10	7,83

Racor Plano Soldar 359 GCu Junta Plana

Raccord 2/P à Souder 8359 GCu Joint Plat / 2/P Soldering Plate Fitting 359 GCu Flat Joint



Sans joint / No joint / Sin junta

CÓDIGO	CÓDIGO EAN	ARTÍCULO	BOLSA	PRECIO (€)
251212	8423545014004	1/2"x12	25	1,69
251214	8423545014011	1/2"x14	25	1,56
251215	8423545014028	1/2"x15	25	1,72
251318	8423545014042	3/4"x18	25	2,49

Racorería de Latón para Soldar / Soldering Brass Fittings / Raccords Laiton à Souder

Raccords Laiton à Souder / Soldering Brass Fittings / Racorería de Latón para Soldar

Racor Soldar 2/P 359 GICu / 2/P Soldering Connector 359 GICu / Raccord 2/P à Souder 8359 GICu



Sin junta / No joint / Sans joint

CÓDIGO	CÓDIGO EAN	ARTÍCULO	BOLSA	PRECIO (€)
252110	8423545014165	3/8"x10	25	1,73
252112	8423545014172	3/8"x12	25	1,76
252114	8423545014189	3/8"x14	25	1,85
252115	8423545014196	3/8"x15	25	1,85
252210	8423545059883	1/2"x10	25	2,08
252212	8423545014202	1/2"x12	25	1,61
252214	8423545014226	1/2"x14	25	1,73
252215	8423545014240	1/2"x15	25	1,64
252216	8423545014264	1/2"x16	25	1,92
252218	8423545014288	1/2"x18	25	2,20
252222	8423545014318	1/2"x22	25	4,14
252314	8423545014332	3/4"x14	25	2,90
252315	8423545014349	3/4"x15	25	2,74
252316	8423545014356	3/4"x16	25	2,97
252318	8423545014363	3/4"x18	25	2,53
252322	8423545014370	3/4"x22	25	2,90
252328	8423545014387	3/4"x28	25	5,86
252418	8423545014394	1"x18	10	4,41
252422	8423545014400	1"x22	10	4,20
252428	8423545014417	1"x28	10	5,17
252528	8423545014424	1" 1/4x28	10	8,07
252535	8423545014431	1" 1/4x35	10	9,12
252635	8423545065969	1" 1/2x35	10	11,65
252642	8423545014448	1" 1/2x42	10	11,65
252754	8423545014455	2"x54	5	22,71

Racor Soldar 2/P 359 GICu con Precinto / 2/P Soldering Connector 359 GICu with Seal / Raccord 2/P à Souder 8359 GICu avec Scellée

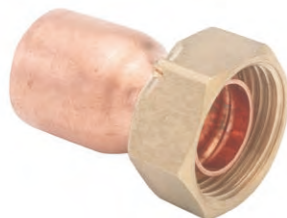

Sin junta / No joint / Sans joint

CÓDIGO	CÓDIGO EAN	ARTÍCULO	BOLSA	PRECIO (€)
250210	8423545013786	1/2"x10	25	2,57
250212	8423545013793	1/2"x12	25	2,00
250214	8423545013809	1/2"x14	25	2,09
250215	8423545013816	1/2"x15	25	1,95
250216	8423545013823	1/2"x16	25	2,09
250218	8423545013830	1/2"x18	25	2,34
250222	8423545013847	1/2"x22	25	4,47
250314	8423545013854	3/4"x14	25	3,28
250315	8423545013861	3/4"x15	25	3,10

Racor Soldar 2/P 359 GICu con Precinto

Raccord 2/P à Souder 8359 GICu avec Scellée / 2/P Soldering Connector 359 GICu with Seal

CÓDIGO	CÓDIGO EAN	ARTÍCULO	BOLSA	PRECIO (€)
250316	8423545013878	3/4"x16	25	3,37
250318	8423545013885	3/4"x18	25	2,83
250322	8423545013892	3/4"x22	25	3,11
250328	8423545013908	3/4"x28	25	6,18
250418	8423545013915	1"x18	25	5,00
250422	8423545013922	1"x22	25	4,53
250428	8423545013939	1"x28	10	5,52
250528	8423545013946	1" 1/4x28	10	8,51
250535	8423545013953	1" 1/4x35	10	9,54
250635	8423545013960	1" 1/2x35	5	13,37
250642	8423545013977	1" 1/2x42	5	13,37
250754	8423545013984	2"x54	5	24,16

Racor Soldar 2/P 359 GICu Junta Plana

Raccord 2/P à Souder 8359 GICu Joint Plat / 2/P Soldering Connector 359 GICu Flat Joint

CÓDIGO	CÓDIGO EAN	ARTÍCULO	BOLSA	PRECIO (€)
253110	8423545014462	3/8"x10	10	1,72
253112	8423545014479	3/8"x12	10	1,40
253114	8423545014486	3/8"x14	10	1,53
253115	8423545059890	3/8"x15	10	1,85
253212	8423545014493	1/2"x12	10	1,54
253214	8423545014509	1/2"x14	10	1,54
253215	8423545014516	1/2"x15	10	1,64
253216	8423545014523	1/2"x16	10	1,67
253218	8423545059128	1/2"x18	10	2,19
253222	8423545060476	1/2"x22	10	4,17
253314	8423545014530	3/4"x14	10	2,60
253315	8423545059647	3/4"x15	10	2,74
253316	8423545014547	3/4"x16	10	2,80
253318	8423545014554	3/4"x18	10	2,53
253322	8423545014561	3/4"x22	10	2,90
253328	8423545062944	3/4"x28	10	5,65
253422	8423545014578	1"x22	10	4,17
253428	8423545014585	1"x28	10	4,96
253528	8423545061787	1" 1/4x28	10	8,06
253535	8423545058879	1" 1/4x35	5	9,11
253642	8423545058886	1" 1/2x42	5	11,65
253754	8423545058893	2"x54	5	23,00

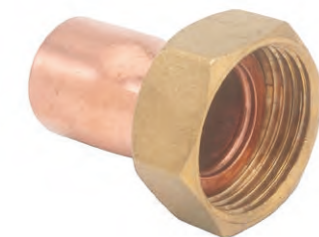

Sans joint / No joint / Sin junta

Racorera de Latón para Tubo de Polietileno / Brass Fittings for Polyethylene Pipe / Raccords Laiton Pour Tube Polyéthylène

Raccords Laiton Pour Tube Polyéthylène / Brass Fittings for Polyethylene Pipe / Racorería de Latón para Tubo de Polietileno

**Codo Tubo-Tubo / Tube-Tube Elbow / Coude Tube-Tube**



CÓDIGO	CÓDIGO EAN	ARTÍCULO	BOLSA	PRECIO (€)
330220	8423545063033	20 mm	-	7,39
330225	8423545063040	25 mm	-	11,40
330232	8423545063057	32 mm	-	17,75
330240	8423545063064	40 mm	-	27,44
330250	8423545063071	50 mm	-	40,80
330263	8423545063088	63 mm	-	71,37

**Codo Tubo-Tubo con Brida / Tube-Tube Elbow with Flange / Coude Tube-Tube avec Etou**



CÓDIGO	CÓDIGO EAN	ARTÍCULO	BOLSA	PRECIO (€)
331275	8423545118832	75 mm	-	228,66
331290	8423545118849	90 mm	-	367,71
331295	8423545118856	110 mm	-	544,87

**Codo Tubo-Macho / Tube-Male Elbow / Coude Tube-Mâle**



CÓDIGO	CÓDIGO EAN	ARTÍCULO	BOLSA	PRECIO (€)
330320	8423545063170	1/2"x20	-	4,93
330325	8423545063187	3/4"x25	-	7,67
330332	8423545063163	1"x32	-	12,20
330340	8423545063194	1"1/4x40	-	21,18
330350	8423545063200	1"1/2x50	-	28,78
330363	8423545063156	2"x63	-	50,45

**Codo Tubo-Hembra / Tube-Female Elbow / Coude Tube-Femelle**



CÓDIGO	CÓDIGO EAN	ARTÍCULO	BOLSA	PRECIO (€)
330120	8423545063095	1/2"x20	-	4,86
330125	8423545063101	3/4"x25	-	7,59
330132	8423545063118	1"x32	-	11,89
330140	8423545063125	1"1/4x40	-	18,97
330150	8423545063132	1"1/2x50	-	26,72
330163	8423545063149	2"x63	-	50,96

**Codo Tubo-Hembra con Brida / Tube-Female Elbow with Flange / Coude Tube-Femelle avec Etou**



CÓDIGO	CÓDIGO EAN	ARTÍCULO	BOLSA	PRECIO (€)
331175	8423545078013	2"1/2x75	-	164,80
331190	8423545078020	3"x90	-	227,63
331195	8423545118825	4"x110	-	391,40

**Applique Mural Tube-Femelle / Tube-Female Wall Elbow / Codo Mural Tubo-Hembra**

CÓDIGO	CÓDIGO EAN	ARTÍCULO	BOLSA	PRECIO (€)
330420	8423545064887	1/2"x20	-	6,46
330425	8423545064894	3/4"x25	-	9,10



**Union Tube-Tube / Tube-Tube Union / Unión Tubo-Tubo**

CÓDIGO	CÓDIGO EAN	ARTÍCULO	BOLSA	PRECIO (€)
334220	8423545063392	20 mm	-	6,46
334225	8423545063408	25 mm	-	10,31
334232	8423545063415	32 mm	-	15,66
334240	8423545063422	40 mm	-	22,21
334250	8423545063439	50 mm	-	32,22
334263	8423545063446	63 mm	-	52,97



**Unión Reducida Tubo-Tubo / Union Réduction Tube-Tube / Tube-Tube Reduced Union**

CÓDIGO	CÓDIGO EAN	ARTÍCULO	BOLSA	PRECIO (€)
340223	8423545077566	20x25	-	8,24

**Union Tube-Tube avec Etou / Tube-Tube Union with Flange / Unión Tubo-Tubo con Brida**

CÓDIGO	CÓDIGO EAN	ARTÍCULO	BOLSA	PRECIO (€)
335275	8423545118863	75 mm	-	182,31
335290	8423545118870	90 mm	-	290,46
335295	8423545118887	110mm	-	435,69



**Union Tube-Mâle / Tube-Male Union / Unión Tubo-Macho**

CÓDIGO	CÓDIGO EAN	ARTÍCULO	BOLSA	PRECIO (€)
334320	8423545063514	1/2"x20	-	4,04
334325	8423545063521	3/4"x25	-	6,12
334332	8423545063538	1"x32	-	9,34
334340	8423545063545	1"1/4x40	-	13,61
334350	8423545063552	1"1/2x50	-	18,59
334363	8423545063569	2"x63	-	31,99



**Union Réduite Tube-Mâle / Tube-Male Reduced Union / Unión Reducida Tubo-Macho**

CÓDIGO	CÓDIGO EAN	ARTÍCULO	BOLSA	PRECIO (€)
340323	8423545077399	1/2"x25	-	5,15
340332	8423545077412	3/4"x20	-	5,15
340354	8423545077467	1"1/4x32	-	8,24

Racorera de Latón para Tubo de Polietileno / Brass Fittings for Polyethylene Pipe / Raccords Laiton Pour Tube Polyéthylène

Raccords Laiton Pour Tube Polyéthylène / Brass Fittings for Polyethylene Pipe / Racorería de Latón para Tubo de Polietileno

Unión Tubo-Macho con Brida / Tube-Male Union with Flange / Union Tube-Mâle avec Etai



CÓDIGO	CÓDIGO EAN	ARTÍCULO	BOLSA	PRECIO (€)
335375	8423545118894	2" 1/2x75	-	107,52
335390	8423545118900	3"x90	-	138,84
335395	8423545118917	4"x110	-	288,40

Unión Tubo-Hembra / Tube-Female Union / Union Tube-Femelle



CÓDIGO	CÓDIGO EAN	ARTÍCULO	BOLSA	PRECIO (€)
334120	8423545063453	1/2"x20	-	4,09
334125	8423545063460	3/4"x25	-	6,27
334132	8423545063477	1"x32	-	10,05
334140	8423545063484	1" 1/4x40	-	16,26
334150	8423545063491	1" 1/2x50	-	21,32
334163	8423545063507	2"x63	-	34,07

Unión Reducida Tubo-Hembra / Tube-Female Reduced Union / Union Réduite Tube-Femelle

CÓDIGO	CÓDIGO EAN	ARTÍCULO	BOLSA	PRECIO (€)
340132	8423545077429	3/4"x20	-	5,04
340143	8423545077443	1"x25	-	7,10

Unión Tubo-Hembra con Brida / Tube-Female Union with Flange / Union Tube-Femelle avec Etai



CÓDIGO	CÓDIGO EAN	ARTÍCULO	BOLSA	PRECIO (€)
335175	8423545118924	2" 1/2x75	-	108,87
335190	8423545118931	3"x90	-	140,99
335195	8423545118948	4"x110	-	265,74

Te Tubo-Tubo / Tube-Tube Tee / Te Tube-Tube



CÓDIGO	CÓDIGO EAN	ARTÍCULO	BOLSA	PRECIO (€)
332220	8423545063217	20 mm	-	10,32
332225	8423545063224	25 mm	-	16,67
332232	8423545063231	32 mm	-	25,17
332240	8423545063248	40 mm	-	37,14
332250	8423545063255	50 mm	-	56,95
332263	8423545063262	63 mm	-	102,03

Te Reducida Tubo-Tubo / Tube-Tube Reduced Tee / Te Réduite Tube-Tube

CÓDIGO	CÓDIGO EAN	ARTÍCULO	BOLSA	PRECIO (€)
338223	8423545077375	25x20x25	-	10,28

Te Tubo-Tubo con Brida / Tube-Tube Tee with Flange / Te Tubo-Tubo con Brida



CÓDIGO	CÓDIGO EAN	ARTÍCULO	BOLSA	PRECIO (€)
333275	8423545118481	75 mm	-	424,36
333290	8423545118498	90 mm	-	522,21
333295	8423545118504	110 mm	-	705,55

Te Tube-Femelle / Tube-Female Tee / Te Tubo-Hembra



CÓDIGO	CÓDIGO EAN	ARTÍCULO	BOLSA	PRECIO (€)
332120	8423545063576	1/2"x20	-	7,88
332125	8423545063361	3/4"x25	-	12,79
332132	8423545063385	1"x32	-	19,68
332140	8423545063330	1" 1/4x40	-	29,54
332150	8423545063347	1" 1/2x50	-	45,50
332163	8423545063378	2"x63	-	76,11

Te Réduite Tube-Femelle / Tube-Female Reduced Tee / Te Reducción Tubo-Hembra

CÓDIGO	CÓDIGO EAN	ARTÍCULO	BOLSA	PRECIO (€)
338323	8423545077351	1/2"x25	-	9,57

Te Tube-Femelle avec Etai / Tube-Female Tee with Flange / Te Tubo-Hembra con Brida



CÓDIGO	CÓDIGO EAN	ARTÍCULO	BOLSA	PRECIO (€)
333175	8423545077214	2" 1/2x75	-	267,81
333190	8423545077221	3"x90	-	443,93
333195	8423545077238	4"x110	-	513,97

Riego / Irrigation / Arrosage

Arrosage / Irrigation / Riego

Lanza-Manguera 3 Efectos / 3 Ways Hose Fitting / Lance 3 Jets



CÓDIGO	CÓDIGO EAN	ARTÍCULO	BOLSA	PRECIO (€)
905016	8423545054505	16 mm	-	9,69
905020	8423545054536	20 mm	-	10,60
905025	8423545054567	25 mm	-	11,86

Entronque Manguera Macho / Male Hose Connection Nipple / Manchon Mâle Arrosage



CÓDIGO	CÓDIGO EAN	ARTÍCULO	BOLSA	PRECIO (€)
311001	8423545016022	3/8" - Ø 13 mm	25	1,42
311002	8423545016039	1/2" - Ø 15 mm	25	1,69
311003	8423545016046	3/4" - Ø 22 mm	10	3,18
311004	8423545016060	1" - Ø 29 mm	10	4,80
311005	8423545016077	1" 1/4 - Ø 34 mm	-	9,16
311006	8423545016084	1" 1/2 - Ø 45mm	-	13,30
311007	8423545016091	2" - Ø 59 mm	-	21,34
311009	8423545016107	3" - Ø 75 mm	-	54,78

Manguito Empalme Manguera / Straight Hose Coupler / Jonction Simple



CÓDIGO	CÓDIGO EAN	ARTÍCULO	BOLSA	PRECIO (€)
655114	8423545035603	3/8"x11	-	5,02
655214	8423545035610	1/2"x14	-	8,02
655320	8423545035634	3/4"x20	-	10,71
655425	8423545035658	1"x25	-	14,31
655530	8423545035665	1" 1/4x30	-	27,27

Te Empalme Manguera / Tee Hose Coupler / Te Jonction



CÓDIGO	CÓDIGO EAN	ARTÍCULO	BOLSA	PRECIO (€)
654114	8423545035528	3/8"x11	-	6,50
654214	8423545035535	1/2"x14	-	10,19
654320	8423545035559	3/4"x20	-	12,35
654425	8423545035573	1"x25	-	26,84

Raccords Rapides Air / Air Quick Connectors / Enchufes Rápidos Aire

Manchon Tube / Hose Coupler / Boquilla Manguera

CÓDIGO	CÓDIGO EAN	ARTÍCULO	BOLSA	PRECIO (€)
614014	8423545033128	ENLACE ENCHUFE RÁPIDO AIRE 3/4"	-	16,65



Demi-raccord Mâle / Male Hose Connector / Enchufe Rápido Macho

CÓDIGO	CÓDIGO EAN	ARTÍCULO	BOLSA	PRECIO (€)
614003	8423545033104	ENCHUFE RÁPIDO AIRE M-3/4"	-	15,30



Demi-raccord Femelle / Female Hose Connector / Enchufe Rápido Hembra

CÓDIGO	CÓDIGO EAN	ARTÍCULO	BOLSA	PRECIO (€)
614013	8423545033111	ENCHUFE RÁPIDO AIRE H-3/4"	-	11,90



Coude Arrosage Spécial "Madrid" / Special Hose Elbow "Madrid" / Colzada Riego "Madrid"

CÓDIGO	CÓDIGO EAN	ARTÍCULO	BOLSA	PRECIO (€)
658006	8423545035696	1" 1/2	-	161,90



Raccord Rapide Mâle Arrosage "Barcelona" / Male Quick Connector "Barcelona" / Racor Rápido Macho "Barcelona"

CÓDIGO	CÓDIGO EAN	ARTÍCULO	BOLSA	PRECIO (€)
611220	8423545032800	1/2"	-	2,92
611325	8423545032831	3/4"	-	3,77
611430	8423545032855	1"	-	5,82
611535	8423545032879	1" 1/4	-	9,92
611645	8423545032893	1" 1/2	-	14,99
611760	8423545032916	2"	-	27,05



Riego / Irrigation / Arrosage

Racor Rápido Manguera "Barcelona" / Hose Quick Connector "Barcelona" / Raccord Rapide Tube Arrosage "Barcelona"



CÓDIGO	CÓDIGO EAN	ARTÍCULO	BOLSA	PRECIO (€)
610020	8423545032589	20 mm	-	3,99
610025	8423545032619	25 mm	-	7,30
610030	8423545032640	30 mm	-	7,80
610035	8423545032671	35 mm	-	10,39
610040	8423545032695	40 mm	-	18,23
610045	8423545032718	45 mm	-	23,50
610050	8423545032732	50 mm	-	23,75
610060	8423545032756	60 mm	-	33,45
610070	8423545032770	70 mm	-	69,65

Racor Manguera 2/P / 2/P Hose Connector / Raccord 2/P Arrosage



CÓDIGO	CÓDIGO EAN	ARTÍCULO	BOLSA	PRECIO (€)
355001	8423545075401	3/8"x10	25	3,69
355002	8423545019382	1/2"x15	25	2,20
355003	8423545019405	3/4"x20	25	3,15
355004	8423545019429	1"x25	10	4,65
355005	8423545019436	1" 1/4x31	-	10,99
355006	8423545019443	1" 1/2x37	-	12,90
355007	8423545019450	2"x46	-	16,65

Racor Manguera 3/P / 3/P Hose Connector / Raccord 3/P Arrosage



CÓDIGO	CÓDIGO EAN	ARTÍCULO	BOLSA	PRECIO (€)
356002	8423545019764	1/2"	25	4,12
356003	8423545019771	3/4"	25	6,35
356004	8423545019788	1"	10	8,50
356005	8423545019795	1" 1/4	-	17,35

Accessoires Réservoir WC / WC Tank Complements / Complementos Cisterna WC

Robinet Flotteur avec Siège Nylon / Float Valve with Nylon Seat / Flotador Olleta con Asiento Nylon

Tige Filetée 3/16 / Rib Thread 3/16 / Rosca Varilla 3/16

CÓDIGO	CÓDIGO EAN	ARTÍCULO	BOLSA	PRECIO (€)
623001	8423545033265	3/8"	10	7,47
623011	8423545033326	3/8" V/22 cm	10	7,55



Tige Filetée 6/100 / Rib Thread 6/100 / Rosca Varilla 6/100

CÓDIGO	CÓDIGO EAN	ARTÍCULO	BOLSA	PRECIO (€)
623002	8423545033289	1/2"	5	10,36
623003	8423545033302	3/4"	5	14,99
623004	8423545033319	1"	3	17,36

Robinet Flotteur à Guides avec Siège Nylon / Guides Float Valve with Nylon Seat / Flotador Guías con Asiento Nylon

CÓDIGO	CÓDIGO EAN	ARTÍCULO	BOLSA	PRECIO (€)
624001	8423545033555	3/8" (3/16*)	5	14,30
624002	8423545033562	1/2" (6/100*)	5	13,45
624003	8423545033579	3/4" (6/100*)	5	18,30
624004	8423545033586	1" (8/100*)	3	24,00
624005	8423545033593	1" 1/4" (9/100*)	-	47,88
624006	8423545033609	1" 1/2" (9/100*)	-	66,69
624007	8423545033616	2" (9/100*)	-	102,26



\* Tige Filetée / Rib Thread / Rosca Varilla

Robinet Flotteur à Guides pour Boule Plate / Guides Float Valve for Plain Ball / Flotador Guías "Safety" para Boya Plana

CÓDIGO	CÓDIGO EAN	ARTÍCULO	BOLSA	PRECIO (€)
641002	8423545035337	1/2"	-	19,29
641003	8423545035344	3/4"	-	23,90
641004	8423545035351	1"	-	29,30
641005	8423545035368	1" 1/4	-	62,35
641006	8423545035375	1" 1/2	-	81,90
641007	8423545035382	2"	-	126,30
641008	8423545035399	2" 1/2	-	513,00
641009	8423545035405	3"	-	947,00



Complementos Cisterna WC / WC Tank Complements / Accessoires Réservoir WC

Flotador Silencioso / Silent Float Valve / Robinet Flotteur Silencieux



Entrada Superior / Water High Entry / Entrée Supérieure

CÓDIGO	CÓDIGO EAN	ARTÍCULO	BOLSA	PRECIO (€)
626001	8423545034200	3/8"	10	9,33

Entrada Inferior / Water Low Entry / Entrée Inférieure

CÓDIGO	CÓDIGO EAN	ARTÍCULO	BOLSA	PRECIO (€)
626101	8423545034255	3/8"	10	9,33

Flotador Silencioso con Boya Porexpan

Silent Float Valve with Porexpan Ball / Robinet Flotteur Silencieux avec Boule Porespan



CÓDIGO	CÓDIGO EAN	ARTÍCULO	BOLSA	PRECIO (€)
622300	8423545068090	GRIFO FLOT. LATON C/BOYA	-	10,36

Boya Expandida / Expanded Float Ball / Boule Expansée



CÓDIGO	CÓDIGO EAN	ARTÍCULO	BOLSA	PRECIO (€)
629109	8423545034507	9 cm 3/8"	-	1,48
629211	8423545034521	11 cm 1/2"	-	2,78
629313	8423545034545	13 cm 3/4"	-	3,45
629416	8423545034576	15 cm (R.8/100) 1"	-	4,41
629620	8423545034590	20 cm 1" 1/4-1" 1/2	-	6,68
629723	8423545034606	23 cm 2"	-	9,02

Boya Latón / Brass Float Ball / Boule Laiton



CÓDIGO	CÓDIGO EAN	ARTÍCULO	BOLSA	PRECIO (€)
628009	8423545034439	9 cm 3/8"	-	25,33
628011	8423545034446	11 cm 1/2"	-	29,53
628013	8423545034453	13 cm 3/4"	-	39,93
628015	8423545034460	15 cm (R.8/100) 1"	-	43,93
628020	8423545034484	20 cm x1" 1/4 - 1" 1/2	-	87,26
628023	8423545034491	23 cm 2"	-	98,20

Accessoires Réservoir WC / WC Tank Complements / Complementos Cisterna WC

Boule Porespan / Porexpan Float Ball / Boya Porexpan

CÓDIGO	CÓDIGO EAN	ARTÍCULO	BOLSA	PRECIO (€)
627009	8423545034378	9 cmx3/8"	-	1,13
627011	8423545034392	11 cmx1/2"	-	1,70
627016	8423545034415	16 cmx3/4"-1"	-	2,99



Boya Cobre Plana para Flotador Safety

Boule Cuivre Plate pour Robinet Flotteur à Guides Tige Plate / Copper Plain Ball Float for Float Valve Guides

CÓDIGO	CÓDIGO EAN	ARTÍCULO	BOLSA	PRECIO (€)
630212	8423545034637	12 cmx1/2"	-	32,66
630315	8423545034644	15 cmx3/4"	-	46,00
630417	8423545034651	17 cmx1"	-	56,00
630520	8423545034668	20 cmx1" 1/4	-	72,86
630623	8423545034675	23 cmx1" 1/2	-	92,26
630725	8423545034682	25 cmx2"	-	110,00
630828	8423545034699	28 cmx2" 1/2	-	158,93
630930	8423545034705	30 cmx3"	-	211,40



Boya Plástico Plana para Flotador Safety

Boule Plastique Plate avec Robinet Flotteur à Guides Tige Plate / Plastic Plain Ball Float for Float Valve Guides

CÓDIGO	CÓDIGO EAN	ARTÍCULO	BOLSA	PRECIO (€)
631015	8423545101247	15 cm	-	8,70
631020	8423545101254	20 cm	-	18,32
631025	8423545101278	25 cm	-	30,22
631030	8423545101292	30 cm	-	82,93



Boule Flotteur / Flush Ball Float Valve / Boya Sifónica

CÓDIGO	CÓDIGO EAN	ARTÍCULO	BOLSA	PRECIO (€)
981701	8423545058282	C/VARILLA LATÓN	-	7,12



Complementos Cisterna WC / WC Tank Complements / Accessoires Réservoir WC

Cisterna WC Plástico / WC Plastic Tank / Réservoir WC Plastique



CÓDIGO	CÓDIGO EAN	ARTÍCULO	BOLSA	PRECIO (€)
636000	8423545035115	CISTERNA WC PLÁSTICO	-	19,00

Equipos Completos Descarga WC Tanque Alto / WC Complete Tank Sets Upper Tank / Kits Complets WC Réservoir Suspendu



CÓDIGO	CÓDIGO EAN	ARTÍCULO	BOLSA	PRECIO (€)
636100	8423545035122	SET NORMAL NORMAL / NORMAL	-	51,26
636200	8423545035139	SET REFORZADO REINFORCED / RENFORCÉ	-	68,22
636700	8423545035146	SET ECONÓMICO ECONOMIC / ECONOMIQUE	-	48,80

Descargas 4 Guías WC a Voluntad / WC 4 Guides Voluntary Cistern Flushings / Chasses d'Eau 4 Guides WC à Volonté



Normal Plomo / Standard Lead / Plomb Normal

CÓDIGO	CÓDIGO EAN	ARTÍCULO	BOLSA	PRECIO (€)
634400	8423545034842	PLOMO LEAD / PLOMB	-	34,36

Muelle / Spring / Ressort

CÓDIGO	CÓDIGO EAN	ARTÍCULO	BOLSA	PRECIO (€)
634300	8423545034798	MUELLE SPRING / RESSORT	-	31,25

Muelle Plomo Reforzada / Spring Lead Stronger / Ressort Plomb Renforcé

CÓDIGO	CÓDIGO EAN	ARTÍCULO	BOLSA	PRECIO (€)
634600	8423545034989	REFORZADA STRONGER / RENFORCÉ	-	47,74

Económica / Economic / Economique

CÓDIGO	CÓDIGO EAN	ARTÍCULO	BOLSA	PRECIO (€)
634700	8423545035016	ECONÓMICA ECONOMIC / ECONOMIQUE	-	31,75

Accessoires Réservoir WC / WC Tank Complements / Complementos Cisterna WC

Chasse D'Eau WC Plastique Réservoir Attenant / WC Lower Tank Plastic Flush / Descarga WC Plástico Tanque Bajo

CÓDIGO	CÓDIGO EAN	ARTÍCULO	BOLSA	PRECIO (€)
634100 (A)	8423545034774	DESCARGA FLUSH / CHASSE D'EAU	-	9,33
634101 (B)	8423545063835	CAMPANA BELL / CLOCHE	-	6,75
634102 (C)	8423545063859	GOMA OBTURADORA RUBBER / CAOUTCHOUC	25	1,75
634103 (D)	8423545068212	JUNTA DESCARGA FLUSH JOINT / JOINT CHASSE D'EAU	-	1,78
980010 (E)	8423545057889	GOMA OBTURADORA LISA PLUGGING JOINT / MEMBRANE CAOUTCHOUC LISSE	25	1,20
933400 (F)	8423545067994	JUNTA PARA WC TANQUE BAJO LOWER TANK WC JOINT / JOINT RESERVOIR ATTENANT	100	2,47



Descarga WC Plástico Tanque Bajo Pulsador

Chasse D'Eau WC Plastique Réservoir Attenant avec Pousoir / WC Lower Tank Plastic Flush with Push Button

CÓDIGO	CÓDIGO EAN	ARTÍCULO	BOLSA	PRECIO (€)
634900	8423545067963	TANQUE BAJO LOWER TANK / RÉ.S. ATTENANT	-	20,78



Chasse WC D'Eau Plastique Réservoir Suspendu / WC Upper Tank Plastic Flush / Descarga WC Plástico Tanque Alto

CÓDIGO	CÓDIGO EAN	ARTÍCULO	BOLSA	PRECIO (€)
634500	8423545034972	DESCARGA FLUSH / CHASSE D'EAU	-	5,71
634501	8423545059876	CAMPANA / BELL / CLOCHE	-	5,16
634502	8423545063842	GOMA OBTURADORA RUBBER / CAOUTCHOUC	-	1,06



Chasse D'Eau WC Electrique 220 V. PRHIE / Electric WC Tank Flush 220 V. PRHIE / Descarga WC Eléctrica 220 V. PRHIE

CÓDIGO	CÓDIGO EAN	ARTÍCULO	BOLSA	PRECIO (€)
980051	8423545058039	DESCARGA ELÉCTRICA ELECTRIC FLUSH / CHASSE D'EAU ELECTRIQUE	1	143,00
980060	8423545059135	BOBINA TÉRMICA 125/220 V. THERMAL COIL 125/220 V. / BOBINE THERMIQUE 125/220 V.	1	63,00
980063	8423545059166	BOYA C/VARILLA PRHIE BALL WITH GUIDE FOR PHRIE / BOULE AVEC TIGE POUR PHRIE	1	17,00



Complementos Cisterna WC / WC Tank Complements / Accessoires Réservoir WC

Enchufes Goma Cubeta WC / WC Rubber Connectors / Manchons WC Caoutchouc

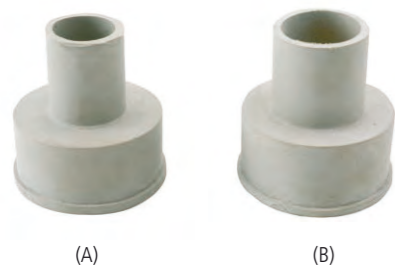

CÓDIGO	CÓDIGO EAN	ARTÍCULO	BOLSA	PRECIO (€)
980001 (A)	8423545057834	N.º 25	25	2,08
980002 (B)	8423545057841	N.º 30	25	2,08

Enchufes Goma Cubeta WC Presión / Pressure WC Rubber Connectors / Manchons WC Caoutchouc Pression

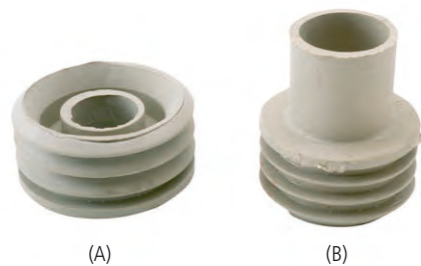

CÓDIGO	CÓDIGO EAN	ARTÍCULO	BOLSA	PRECIO (€)
980004 (A)	8423545062746	WC VICTORIA	25	2,58
980005 (B)	8423545057858	LUCERNA 25/30	25	2,37

Palancas Acopladas para WC Tanque Alto / WC Levers for Upper Tank Flushing / Leviers WC pour Réservoir Suspendu



CÓDIGO	CÓDIGO EAN	ARTÍCULO	BOLSA	PRECIO (€)
631100 (A)	8423545034712	SOPORTE HIERRO IRON SUPPORT / SUPPORT FER	-	2,65
631200 (B)	8423545034736	SOPORTE LATÓN BRASS SUPPORT / SUPPORT LAITON	-	6,55
631300 (B)	8423545034743	SOPORTE LATÓN REFORZADO REINFORCED BRASS SUPPORT / SUPPORT LAITON RENFORCÉ	-	7,35

Accessoires Réservoir WC / WC Tank Complements / Complementos Cisterna WC

Vis pour Accessoires WC / Screws for WC Complements / Tornillos para Accesorios WC

CÓDIGO	CÓDIGO EAN	ARTÍCULO	BOLSA	PRECIO (€)
910100 (A)	8423545054604	JUEGO TORNILLO SUJECIÓN PALANCA W.C	2	1,87
911100 (B)	8423545054628	JUEGO TORNILLOS HIERRO SUJECIÓN WC 5x60	2	2,66
911200 (C)	8423545054635	JUEGO TORNILLOS LATÓN SUJECIÓN W.C M-5x75	2	3,58
911300 (D)	8423545068045	JUEGO TORNILLO SUJECIÓN CISTERNA WC TANQUE BAJO	2	4,92

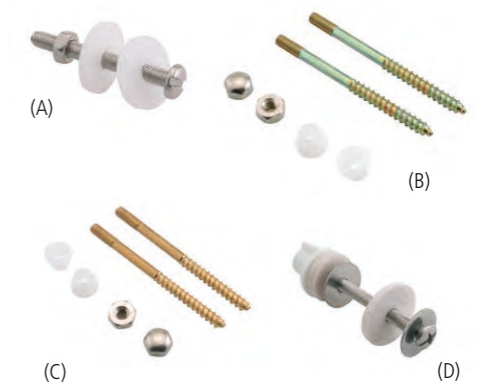

Tirettes WC Réservoir Suspendu / WC Handles Upper Tank / Tiradores WC Tanque Alto

CÓDIGO	CÓDIGO EAN	ARTÍCULO	BOLSA	PRECIO (€)
920148 (A)	8423545054826	TIRADOR WC RECTO PLÁSTICO CON CADENA TANQUE ALTO	10	3,02
920161 (B)	8423545054864	TIRADOR WC RECTO METACRILATO CON CADENA TANQUE ALTO	1	4,63



Tirettes WC Réservoir Attenant / WC Handles Lower Tank / Tiradores WC Tanque Bajo

Laiton Chromé / Chromium-Plated Brass / Latón Cromado

CÓDIGO	CÓDIGO EAN	ARTÍCULO	BOLSA	PRECIO (€)
980015	8423545057902	TIRADOR WC LATÓN CURVO TANQUE BAJO	1	5,37
980016	8423545057926	TIRADOR WC LATÓN RECTO TANQUE BAJO	1	5,37

ABS Chromé / Chromium-Plated ABS / ABS Cromado

CÓDIGO	CÓDIGO EAN	ARTÍCULO	BOLSA	PRECIO (€)
980115	8423545058152	TIRADOR WC ABS CURVO TANQUE BAJO	1	4,00
980116	8423545058176	TIRADOR WC ABS RECTO TANQUE BAJO	1	3,95



# VC<sup>02</sup>

## Válvulas y Conexiones Inox

Valves and Stainless Steel Hoses

*Valves et Flexibles Sanitaires*

Producción con latón según Normas EN12164, EN12165 & EN1982.

Made with brass under EN12164, EN12165 & EN1982 Norms.

Production avec laiton selon Normes EN12164, EN12165 & EN1982.

**Válvulas Esfera**  
Ball Valves / *Vannes à Boisseau*



62

**Válvulas Retención**  
Retention Valves / *Clapets Anti-retour*



66

**Conexiones Inox**  
Stainless Steel Hoses / *Flexibles Sanitaires Inox*



68

Válvulas Esfera / Ball Valves / Vannes à Boisseau

Vannes à Boisseau / Ball Valves / Válvulas Esfera

Válvula Esfera H-H / F-F Ball Valve / Vanne à Boisseau F-F



CÓDIGO	CÓDIGO EAN	ARTÍCULO	BOLSA/CAJA	PRECIO (€)
488044	8423545025598	1/4"	20	6,65
488001	8423545025437	3/8"	20	6,51
488002	8423545025451	1/2"	10	10,76
488003	8423545025475	3/4"	10	15,99
488004	8423545025499	1"	10	24,72
488005	8423545025505	1" 1/4	6	35,13
488006	8423545025512	1" 1/2	6	48,04
488007	8423545025529	2"	4	75,98
488008	8423545025536	2" 1/2	-	196,78
488009	8423545025543	3"	-	229,68
488088	8423545025604	4"	-	295,76

Válvula Esfera M-H / M-F Ball Valve / Vanne à Boisseau M-F



CÓDIGO	CÓDIGO EAN	ARTÍCULO	BOLSA/CAJA	PRECIO (€)
492001	8423545059456	3/8"	20	7,41
492002	8423545026014	1/2"	10	10,76
492003	8423545026021	3/4"	10	15,99
492004	8423545059463	1"	10	17,99

Válvula Esfera Mariposa H-H / Full Way Wing Handle F-F Ball Valve / Vanne à Boisseau Papillon Passage Total F-F



CÓDIGO	CÓDIGO EAN	ARTÍCULO	BOLSA/CAJA	PRECIO (€)
494001	8423545060445	3/8"	20	6,48
494002	8423545026038	1/2"	10	10,66
494003	8423545026045	3/4"	10	15,99
494004	8423545059500	1"	10	18,98

Válvula Esfera Mariposa M-H / Full Way Wing Handle M-F Ball Valve / Vanne à Boisseau Papillon Passage Total M-F



CÓDIGO	CÓDIGO EAN	ARTÍCULO	BOLSA/CAJA	PRECIO (€)
496002	8423545059517	1/2"	10	10,66
496003	8423545059524	3/4"	10	15,99
496004	8423545059531	1"	10	20,28

Grifo Esfera Codo Manguera  
Robinet Puisage à Boisseau Raccord au Nez / Full Way Square Ball Tap 2p.Hose Connector



CÓDIGO	CÓDIGO EAN	ARTÍCULO	BOLSA/CAJA	PRECIO (€)
490002	8423545025970	1/2"x3/4"	10	9,24
490003	8423545025994	3/4"x1"	10	11,11
490004	8423545026007	1"x1" 1/4	10	20,28

Vanne à Boisseau Passage Total à Souder / Full Way Soldering Ball Valve / Válvula Esfera Soldar



CÓDIGO	CÓDIGO EAN	ARTÍCULO	BOLSA/CAJA	PRECIO (€)
488015	8423545025550	15 mm	10	9,58
488018	8423545025567	18 mm	10	9,94
488022	8423545025574	22 mm	10	19,29
488028	8423545025581	28 mm	10	26,37

Vanne à Boisseau Mini F-F / F-F Mini Ball Valve / Válvula Esfera Mini H-H



CÓDIGO	CÓDIGO EAN	ARTÍCULO	BOLSA/CAJA	PRECIO (€)
488144	8423545025659	1/4"	20	6,37
488101	8423545025611	3/8"	20	6,37
488102	8423545025628	1/2"	20	8,29
488103	8423545025635	3/4"	10	12,10

Vanne à Boisseau Mini M-F / M-F Mini Ball Valve / Válvula Esfera Mini M-H



CÓDIGO	CÓDIGO EAN	ARTÍCULO	BOLSA/CAJA	PRECIO (€)
488444	8423545025956	1/4"	20	6,34
488111	8423545025642	3/8"	20	8,28
488222	8423545025772	1/2"	20	8,78
488333	8423545025833	3/4"	10	13,76

Válvulas Esfera / Ball Valves / Vannes à Boisseau

Vannes à Boisseau / Ball Valves / Válvulas Esfera

Llave Roscar "Vic" / Threaded Head "Vic" / Corps Vanne Fileté "Vic"



CÓDIGO	CÓDIGO EAN	ARTÍCULO	BOLSA/CAJA	PRECIO (€)
290002	8423545091982	1/2"	5	17,55
290003	8423545091999	3/4"	5	21,64
290004	8423545092002	1"	5	25,41

Llave Soldar "Vic" / Soldering Head "Vic" / Corps Vanne à Souder "Vic"



CÓDIGO	CÓDIGO EAN	ARTÍCULO	BOLSA/CAJA	PRECIO (€)
290015	8423545092026	15 mm	5	14,28
290018	8423545092040	18 mm	5	16,88
290022	8423545092057	22 mm	5	21,93
290028	8423545092064	28 mm	5	38,98

Volante "Vic" / Handle "Vic" / Tête "Vic"



CÓDIGO	CÓDIGO EAN	ARTÍCULO	BOLSA/CAJA	PRECIO (€)
290100	8423545091951	REDONDO ROUND / RONDE	5	6,74



CÓDIGO	CÓDIGO EAN	ARTÍCULO	BOLSA/CAJA	PRECIO (€)
290110	8423545091968	LARGO LARGE / LONG	5	6,74

Tête "Vic" / Handle "Vic" / Volante "Vic"

CÓDIGO	CÓDIGO EAN	ARTÍCULO	BOLSA/CAJA	PRECIO (€)
290120	8423545091975	OCULTO HIDDEN / CACHÉ	5	6,44



Allonge "Vic" / Extension Piece "Vic" / Alargadera "Vic"

CÓDIGO	CÓDIGO EAN	ARTÍCULO	BOLSA/CAJA	PRECIO (€)
290500	8423545100530	25 mm	25	1,56



Corps Vanne à Souder avec Tête "Marina" / Soldering Head with Handle "Marina" / Llave Soldar con Volante "Marina"

CÓDIGO	CÓDIGO EAN	ARTÍCULO	BOLSA/CAJA	PRECIO (€)
288015	8423545015100	15 mm ABS	1	6,48
288018	8423545015124	18 mm ABS	1	6,48
288022	8423545015131	22 mm ABS	1	6,51
289015	8423545015247	15 mm METAL	1	12,89
289018	8423545015261	18 mm METAL	1	12,89
289022	8423545015278	22 mm METAL	1	12,93



Robinet Arrêt à Encastrer "Marina" / Embed Angle Valve "Marina" / Llave Soldar Oculta "Marina"

CÓDIGO	CÓDIGO EAN	ARTÍCULO	CAJA	PRECIO (€)
827015	8423545045596	15 mm	1	11,44
827018	8423545045602	18 mm	1	11,44
827022	8423545045619	22 mm	1	11,44

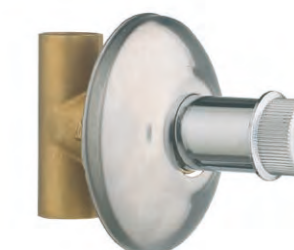

Válvulas Retención / Retention Valves / Clapets Anti-retour

Válvula Compuerta / Gate Valve / Vanne à Soupape



CÓDIGO	CÓDIGO EAN	ARTÍCULO	BOLSA/CAJA	PRECIO (€)
481002	8423545024461	1/2"	-	12,71
481003	8423545024478	3/4"	-	13,78
481004	8423545024485	1"	-	20,54
481005	8423545024492	1" 1/4	-	33,28
481006	8423545024508	1" 1/2	-	42,32
481007	8423545024515	2"	-	64,41
481008	8423545024522	2" 1/2	-	125,81
481009	8423545024539	3"	-	164,68
481088	8423545024553	4"	-	379,47

Válvula Retención / Retention Valve / Clapet Anti-retour



CÓDIGO	CÓDIGO EAN	ARTÍCULO	BOLSA/CAJA	PRECIO (€)
870002	8423545052280	1/2"	-	6,33
870003	8423545052297	3/4"	-	8,18
870004	8423545052310	1"	-	11,99
870005	8423545052327	1" 1/4	-	19,95
870006	8423545052334	1" 1/2	-	28,48
870007	8423545052341	2"	-	40,60
870008	8423545052358	2" 1/2	-	78,70
870009	8423545052365	3"	-	140,60
870088	8423545052372	4"	-	190,00

Filtro Válvula Retención ABS / Retention Valve ABS Filter / Crépine ABS Clapet Anti-retour



CÓDIGO	CÓDIGO EAN	ARTÍCULO	BOLSA/CAJA	PRECIO (€)
871102	8423545052709	1/2"	-	0,67
871103	8423545052716	3/4"	-	0,69
871104	8423545052723	1"	-	0,92
871105	8423545052730	1" 1/4	-	1,49
871106	8423545052747	1" 1/2	-	1,49
871107	8423545052754	2"	-	2,39

Clapets Anti-retour / Retention Valves / Válvulas Retención

Crépine Inox Clapet Anti-retour / Retention Valve Inox Filter / Filtro Válvula Retención Inox

CÓDIGO	CÓDIGO EAN	ARTÍCULO	BOLSA/CAJA	PRECIO (€)
872002	8423545052761	1/2"	-	1,62
872003	8423545052778	3/4"	-	2,34
872004	8423545052792	1"	-	3,74
872005	8423545052808	1" 1/4	-	5,25
872006	8423545052815	1" 1/2	-	7,26
872007	8423545052822	2"	-	9,90
872008	8423545052839	2" 1/2	-	10,12
872009	8423545052846	3"	-	14,88
872088	8423545052853	4"	-	16,22

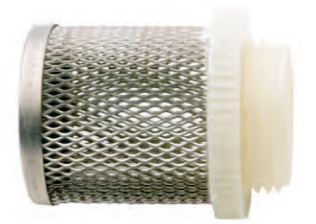

Filtre Incliné / Slanting Filter / Filtro Inclinado

CÓDIGO	CÓDIGO EAN	ARTÍCULO	BOLSA/CAJA	PRECIO (€)
872502	8423545063675	1/2"	-	8,51
872503	8423545063682	3/4"	-	18,85
872504	8423545063699	1"	-	25,74
872505	8423545063705	1" 1/4	-	46,93
872506	8423545052860	1" 1/2	-	59,02
872507	8423545062326	2"	-	110,63



Clapet à Battant / Retention Valve / Válvula Retención Clapeta

CÓDIGO	CÓDIGO EAN	ARTÍCULO	BOLSA/CAJA	PRECIO (€)
875002	8423545052884	1/2"	-	11,98
875003	8423545052891	3/4"	-	17,94
875004	8423545052907	1"	-	26,45
875005	8423545052914	1" 1/4	-	34,90
875006	8423545052921	1" 1/2	-	62,38
875007	8423545052932	2"	-	68,51
875008	8423545052945	2" 1/2	-	135,72
875009	8423545052952	3"	-	307,84



Joint plat / Rubber joint / Cierre de goma

Purgeur Solar / Solar Purger / Purgador Solar

CÓDIGO	CÓDIGO EAN	ARTÍCULO	BOLSA/CAJA	PRECIO (€)
873000	8423545118450	1/2"	1	10,93



**Conexiones Inox / Stainless Steel Hoses / Flexibles Inox**

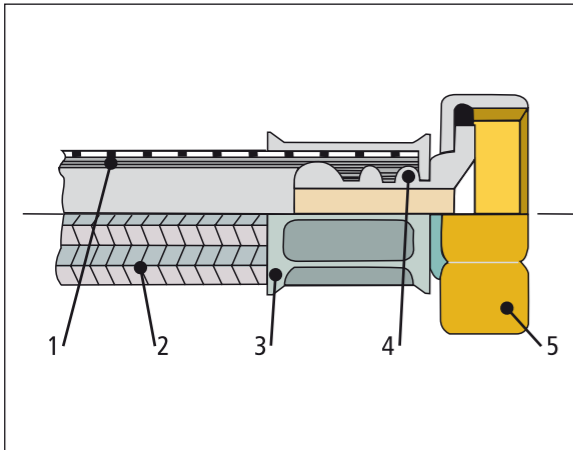

- 1 – Tubo EPDM-80 según Normas UNE 53526/1°R, UNE 53130 y UNE 53510/1°R
  - 2 – Trenzado en hilo de acero inox AISI 304
  - 3 – Campana de acero inox AISI 304/16-547(M) UNE 53626/2/2011
  - 4 – Boquilla de latón CuZn39Pb3
  - 5 – Tuerca de latón estampado niquelado con junta
- 1 – EPDM-80 tube according to UNE 53526/1°R, UNE 53130 and UNE 53510/1°R Norms  
 2 – Brided stainless steel wire AISI 304  
 3 – Stainless steel bushing AISI 304/16-547(M) UNE 53626/2/2011  
 4 – Brass nozzle CuZn39Pb3  
 5 – Nickel-plated stamped brass nut with joint
- 1 – Tube EPDM-80 selon Normes UNE 53526/1°R, UNE 53130 et UNE 53510/1°R  
 2 – Tressé avec fil d'acier inox AISI 304  
 3 – Douille d'acier inox AISI 304/16-547(M) UNE 53626/2/2011  
 4 – Buse en laiton CuZn39Pb3  
 5 – Ecrou en laiton matricié nickelé avec joint

**Conexiones Standard / Standard Stainless Steel Hoses / Flexibles Standard**



Presión 16 bars / Pressure 16 bars / Pression 16 bars + 90°C Temp.

**H-H 3/8"-3/8" / F-F 3/8"-3/8" / F-F 3/8"-3/8"**  
 ø Int. 8,3 mm ø Ext. 12,1 mm Paso Racord 6 mm

CÓDIGO	CÓDIGO EAN	ARTÍCULO	BOLSA/CAJA	PRECIO (€)
863110	8423545050897	10 cm	10	3,57
863115	8423545050910	15 cm	10	3,60
863120	8423545050934	20 cm	10	3,69
863125	8423545050958	25 cm	10	3,99
863130	8423545050972	30 cm	10	4,30
863135	8423545050996	35 cm	10	4,57
863140	8423545075272	40 cm	10	4,58
863145	8423545051030	45 cm	10	4,75
863150	8423545051054	50 cm	10	5,05
863160	8423545051078	60 cm	10	6,65
863170	8423545051092	70 cm	10	6,92
863180	8423545065037	80 cm	10	7,11
863190	8423545065044	90 cm	10	8,76
863191	8423545063002	100 cm	10	9,49
863250	8423545091685	150 cm	10	12,12

**M-H 3/8"-3/8" / M-F 3/8"-3/8" / M-F 3/8"-3/8"**  
 ø Int. 8,3 mm ø Ext. 12,1 mm Paso Racord 6 mm

CÓDIGO	CÓDIGO EAN	ARTÍCULO	BOLSA/CAJA	PRECIO (€)
861110	8423545050392	10 cm	10	3,14
861115	8423545050415	15 cm	10	3,51
861120	8423545050439	20 cm	10	3,67
861125	8423545050453	25 cm	10	4,00
861130	8423545050477	30 cm	10	4,30
861135	8423545050491	35 cm	10	4,95
861140	8423545050514	40 cm	10	5,07
861145	8423545050538	45 cm	10	5,39
861150	8423545050552	50 cm	10	5,60
861160	8423545050576	60 cm	10	5,86
861170	8423545050590	70 cm	10	6,14
861180	8423545063606	80 cm	10	6,03
861190	8423545065082	90 cm	10	6,71
861191	8423545050606	100 cm	10	7,56
861250	8423545091746	150 cm	10	10,85

**M-H 3/8"-1/2" / M-F 3/8"-1/2" / M-F 3/8"-1/2"**  
 ø Int. 8,3 mm ø Ext. 12,1 mm Paso Racord 6 mm

CÓDIGO	CÓDIGO EAN	ARTÍCULO	BOLSA/CAJA	PRECIO (€)
862110	8423545050651	10 cm	10	3,54
862115	8423545050675	15 cm	10	3,54
862120	8423545050699	20 cm	10	4,21
862125	8423545050712	25 cm	10	5,09
862130	8423545050736	30 cm	10	5,10
862135	8423545050750	35 cm	10	5,20
862140	8423545050774	40 cm	10	5,34
862145	8423545050798	45 cm	10	5,70
862150	8423545050811	50 cm	10	6,12
862160	8423545050835	60 cm	10	6,70
862170	8423545050859	70 cm	10	6,99
862191	8423545091630	100 cm	10	8,87
862250	8423545091654	150 cm	10	13,83

**Flexibles Inox / Stainless Steel Hoses / Conexiones inox**

**F-F 3/8"-1/2" / F-F 3/8"-1/2" / H-H 3/8"-1/2"**  
 ø Int. 8,3 mm ø Ext. 12,1 mm Paso Racord 6 mm

CÓDIGO	CÓDIGO EAN	ARTÍCULO	BOLSA/CAJA	PRECIO (€)
864110	8423545051108	10 cm	10	3,48
864115	8423545051122	15 cm	10	4,04
864120	8423545051146	20 cm	10	4,48
864125	8423545051160	25 cm	10	4,75
864130	8423545051184	30 cm	10	4,81
864135	8423545051207	35 cm	10	5,12
864140	8423545051221	40 cm	10	5,18
864145	8423545051245	45 cm	10	5,95
864150	8423545051269	50 cm	10	5,99
864160	8423545051283	60 cm	10	6,11
864170	8423545051306	70 cm	10	6,55
864180	8423545051320	80 cm	10	8,24
864190	8423545065099	90 cm	10	9,13
864191	8423545080194	100 cm	10	9,65

**M-F 1/2"-3/8" / M-F 1/2"-3/8" / M-H 1/2"-3/8"**  
 ø Int. 8,3 mm ø Ext. 12,1 mm Paso Racord 6 mm

CÓDIGO	CÓDIGO EAN	ARTÍCULO	BOLSA/CAJA	PRECIO (€)
867210	8423545051726	10 cm	10	3,93
867215	8423545051740	15 cm	10	4,17
867220	8423545051764	20 cm	10	4,40
867225	8423545051788	25 cm	10	4,57
867230	8423545051801	30 cm	10	4,86
867235	8423545051825	35 cm	10	5,14
867240	8423545051849	40 cm	10	5,38
867245	8423545051863	45 cm	10	5,52
867250	8423545051887	50 cm	10	5,77
867260	8423545051900	60 cm	10	6,29
867270	8423545065051	70 cm	10	6,56
867280	8423545065068	80 cm	10	8,16
867291	8423545077054	100 cm	10	9,13

**F-F 1/2"-1/2" / F-F 1/2"-1/2" / H-H 1/2"-1/2"**  
 ø Int. 8,3 mm ø Ext. 12,1 mm Paso Racord 6 mm

CÓDIGO	CÓDIGO EAN	ARTÍCULO	BOLSA/CAJA	PRECIO (€)
868210	8423545051962	10 cm	10	4,42
868215	8423545051986	15 cm	10	4,57
868220	8423545052006	20 cm	10	4,61
868225	8423545052020	25 cm	10	4,65
868230	8423545052044	30 cm	10	4,68
868235	8423545052068	35 cm	10	4,94
868240	8423545052082	40 cm	10	5,51
868245	8423545052105	45 cm	10	5,74
868250	8423545052129	50 cm	10	5,91
868260	8423545052143	60 cm	10	6,53
868270	8423545052167	70 cm	10	6,70
868280	8423545052174	80 cm	10	11,58
868290	8423545052181	90 cm	10	11,87
868291	8423545052198	100 cm	10	12,58

**M-F 1/2"-1/2" / M-F 1/2"-1/2" / M-H 1/2"-1/2"**  
 ø Int. 8,3 mm ø Ext. 12,1 mm Paso Racord 6 mm

CÓDIGO	CÓDIGO EAN	ARTÍCULO	BOLSA/CAJA	PRECIO (€)
866210	8423545051443	10 cm	10	4,55
866215	8423545051467	15 cm	10	4,38
866220	8423545065723	20 cm	10	4,42
866225	8423545051504	25 cm	10	4,74
866230	8423545051528	30 cm	10	5,27
866235	8423545051542	35 cm	10	5,42
866240	8423545051566	40 cm	10	5,69
866245	8423545051580	45 cm	10	5,99
866250	8423545075265	50 cm	10	6,47
866260	8423545051627	60 cm	10	6,90
866270	8423545051641	70 cm	10	7,55
866280	8423545051658	80 cm	10	10,75
866290	8423545061756	90 cm	10	11,09
866291	8423545051665	100 cm	10	12,24

**Flexibles Inox Compteur d'Eau / Water Meter Stainless Steel Hoses / Conexiones Inox Contador Agua**

**F-F 3/4"-3/4" / F-F 3/4"-3/4" / H-H 3/4"-3/4"**  
 ø Int. 19 mm

CÓDIGO	CÓDIGO EAN	ARTÍCULO	BOLSA/CAJA	PRECIO (€)
877330	8423545060193	30 cm	-	21,21
877335	8423545065143	35 cm	-	22,73
877340	8423545053027	40 cm	-	24,27
877350	8423545061695	50 cm	-	27,31
877360	8423545065167	60 cm	-	30,36
877370	8423545065174	70 cm	-	33,41
877380	8423545065181	80 cm	-	36,46
877390	8423545065198	90 cm	-	39,50
877300	8423545064955	100 cm	-	42,56



Pression 15 kg/cm<sup>2</sup> / Pressure 15 kg/cm<sup>2</sup> / Presión 15 kg/cm<sup>2</sup> + 90°C Temp.

Conexiones Inox / Stainless Steel Hoses / Flexibles Inox

Conexiones Inox Contador Agua / Water Meter Stainless Steel Hoses / Flexibles Inox Compteur d'Eau



Presión 15 kg/cm<sup>2</sup> / Pressure 15 kg/cm<sup>2</sup> / Pression 15 kg/cm<sup>2</sup>  
+ 90°C Temp.

H-H 1"-1" / F-F 1"-1" / F-F 1"-1"  
ø Int. 25 mm

CÓDIGO	CÓDIGO EAN	ARTÍCULO	BOLSA/CAJA	PRECIO (€)
877430	8423545059449	30 cm	-	32,20
877435	8423545065204	35cm	-	34,12
877440	8423545064214	40 cm	-	36,04
877450	8423545064948	50 cm	-	39,88
877460	8423545065211	60 cm	-	43,73
877470	8423545065228	70 cm	-	47,56
877480	8423545065235	80 cm	-	51,41
877490	8423545065242	90 cm	-	58,50
877400	8423545062456	100 cm	-	59,09

Conexiones Termo Inox / Heating Stainless Steel Hoses / Flexibles Chauffage Inox



Presión 10 bars / Pressure 10 bars / Pression 10 bars  
+ 90°C Temp.

H-H 1/2"-1/2" / F-F 1/2"-1/2" / F-F 1/2"-1/2"  
ø Int. 13,3 mm ø Ext. 19 mm Paso Racord 10 mm

CÓDIGO	CÓDIGO EAN	ARTÍCULO	BOLSA/CAJA	PRECIO (€)
898215	8423545054208	15 cm	10	7,05
898220	8423545054215	20 cm	10	7,22
898225	8423545054222	25 cm	10	8,19
898230	8423545054239	30 cm	10	9,28
898235	8423545054246	35 cm	10	9,62
898240	8423545054253	40 cm	10	9,82
898245	8423545054260	45 cm	10	10,23
898250	8423545054277	50 cm	10	10,63
898260	8423545054284	60 cm	10	11,41
898270	8423545065730	70 cm	10	12,36

H-H 1/2"-3/4" / F-F 1/2"-3/4" / F-F 1/2"-3/4"  
ø Int. 13,3 mm ø Ext. 19 mm Paso Racord 10 mm

CÓDIGO	CÓDIGO EAN	ARTÍCULO	BOLSA/CAJA	PRECIO (€)
894315	8423545053850	15 cm	10	8,24
894320	8423545053867	20 cm	10	8,73
894325	8423545053874	25 cm	10	9,63
894330	8423545053881	30 cm	10	10,46
894335	8423545053898	35 cm	10	10,88
894340	8423545053904	40 cm	10	11,34
894345	8423545053911	45 cm	10	13,28
894350	8423545053928	50 cm	10	13,49
894360	8423545053935	60 cm	10	15,05
894370	8423545053942	70 cm	10	15,47

M-H 1/2"-1/2" / M-F 1/2"-1/2" / M-F 1/2"-1/2"  
ø Int. 13,3 mm ø Ext. 19 mm Paso Racord 10 mm

CÓDIGO	CÓDIGO EAN	ARTÍCULO	BOLSA/CAJA	PRECIO (€)
897215	8423545054062	15 cm	10	7,17
897220	8423545054079	20 cm	10	7,52
897225	8423545054086	25 cm	10	8,17
897230	8423545054093	30 cm	10	9,28
897235	8423545054109	35 cm	10	9,62
897240	8423545054116	40 cm	10	9,81
897245	8423545054123	45 cm	10	10,23
897250	8423545054130	50 cm	10	10,63
897260	8423545054147	60 cm	10	11,41
897270	8423545062975	70 cm	10	12,68

F-F 3/4"-3/4" / F-F 3/4"-3/4" / H-H 3/4"-3/4"  
ø Int. 13,3 mm ø Ext. 19 mm Paso Racord 10 mm

CÓDIGO	CÓDIGO EAN	ARTÍCULO	BOLSA/CAJA	PRECIO (€)
893315	8423545053751	15 cm	10	9,13
893320	8423545053768	20 cm	10	10,12
893325	8423545053775	25 cm	10	10,51
893330	8423545053782	30 cm	10	11,29
893335	8423545075258	35 cm	10	11,44
893340	8423545053805	40 cm	10	11,76
893345	8423545053812	45 cm	10	11,77
893350	8423545053829	50 cm	10	12,92
893360	8423545053836	60 cm	10	13,93
893370	8423545053843	70 cm	10	15,15

M-F 3/4"-1/2" / M-F 3/4"-1/2" / M-H 3/4"-1/2"  
ø Int. 13,3 mm ø Ext. 19 mm Paso Racord 10 mm

CÓDIGO	CÓDIGO EAN	ARTÍCULO	BOLSA/CAJA	PRECIO (€)
892315	8423545053652	15 cm	10	7,94
892320	8423545053669	20 cm	10	8,46
892325	8423545053676	25 cm	10	10,80
892330	8423545053683	30 cm	10	10,88
892335	8423545053690	35 cm	10	12,02
892340	8423545053706	40 cm	10	12,23
892345	8423545053713	45 cm	10	12,35
892350	8423545053720	50 cm	10	13,79
892360	8423545053737	60 cm	10	13,84
892370	8423545062982	70 cm	10	14,26

M-F 1/2"-3/4" / M-F 1/2"-3/4" / M-H 1/2"-3/4"  
ø Int. 13,3 mm ø Ext. 19 mm Paso Racord 10 mm

CÓDIGO	CÓDIGO EAN	ARTÍCULO	BOLSA/CAJA	PRECIO (€)
896315	8423545053966	15 cm	10	8,38
896320	8423545053973	20 cm	10	9,02
896325	8423545053980	25 cm	10	9,49
896330	8423545053997	30 cm	10	9,75
896335	8423545054000	35 cm	10	9,98
896340	8423545054017	40 cm	10	10,38
896345	8423545054024	45 cm	10	11,45
896350	8423545054031	50 cm	10	12,06
896360	8423545054048	60 cm	10	14,36
896370	8423545065747	70 cm	10	14,65

M-F 3/4"-3/4" / M-F 3/4"-3/4" / M-H 3/4"-3/4"  
ø Int. 13,3 mm ø Ext. 19 mm Paso Racord 10 mm

CÓDIGO	CÓDIGO EAN	ARTÍCULO	BOLSA/CAJA	PRECIO (€)
891315	8423545053553	15 cm	10	8,87
891320	8423545053560	20 cm	10	9,49
891325	8423545053577	25 cm	10	10,15
891330	8423545053584	30 cm	10	10,41
891335	8423545053591	35 cm	10	10,80
891340	8423545053607	40 cm	10	11,86
891345	8423545053614	45 cm	10	12,18
891350	8423545053621	50 cm	10	12,87
891360	8423545053638	60 cm	10	13,65
891370	8423545053645	70 cm	10	17,01

**Conexiones Galvanizadas Bomba de Agua / Water Pump Galvanized Hoses / Flexibles Galvanisés Pompe d'Eau**

**Conexiones Galvanizadas Bomba de Agua / Water Pump Galvanized Hoses / Flexibles Galvanisés Pompe d'Eau**



Presión 15 kg/cm<sup>2</sup> / Pressure 15 kg/cm<sup>2</sup> / Pression 15 kg/cm<sup>2</sup>  
+ 90°C Temp.

**M-H 3/4"-3/4" / M-F 3/4"-3/4" / M-F 3/4"-3/4"**  
ø Int. 19 mm

CÓDIGO	CÓDIGO EAN	ARTÍCULO	BOLSA/CAJA	PRECIO (€)
881030	8423545053133	30 cm	-	15,66
881040	8423545053140	40 cm	-	17,65
881050	8423545053157	50 cm	-	19,65
881060	8423545053164	60 cm	-	21,65
881070	8423545053171	70 cm	-	23,65
881080	8423545053188	80 cm	-	25,65
881090	8423545065662	90 cm	-	27,69
881100	8423545053195	100 cm	-	29,64

**M-H 1"-1" / M-F 1"-1" / M-F 1"-1"**  
ø Int. 25 mm

CÓDIGO	CÓDIGO EAN	ARTÍCULO	BOLSA/CAJA	PRECIO (€)
882030	8423545053225	30 cm	-	22,70
882040	8423545053232	40 cm	-	25,28
882050	8423545053249	50 cm	-	27,87
882060	8423545053256	60 cm	-	30,45
882070	8423545053263	70 cm	-	33,03
882080	8423545053270	80 cm	-	35,62
882090	8423545065679	90 cm	-	38,20
882100	8423545053287	100 cm	-	40,79

**M-H 1"1/2-1"1/2 / M-F 1"1/2-1"1/2 / M-F 1"1/2-1"1/2**  
ø Int. 40 mm

CÓDIGO	CÓDIGO EAN	ARTÍCULO	BOLSA/CAJA	PRECIO (€)
884030	8423545053379	30 cm	-	63,41
884040	8423545053386	40 cm	-	72,28
884050	8423545053393	50 cm	-	81,14
884060	8423545053409	60 cm	-	90,01
884070	8423545053416	70 cm	-	98,87
884080	8423545053423	80 cm	-	107,74
884090	8423545065693	90 cm	-	116,00
884100	8423545053430	100 cm	-	125,47

**M-H 1"1/4-1"1/4 / M-F 1"1/4-1"1/4 / M-F 1"1/4-1"1/4**  
ø Int. 30 mm

CÓDIGO	CÓDIGO EAN	ARTÍCULO	BOLSA/CAJA	PRECIO (€)
883030	8423545053300	30 cm	-	42,86
883040	8423545053317	40 cm	-	48,22
883050	8423545053324	50 cm	-	53,58
883060	8423545053331	60 cm	-	58,94
883070	8423545053348	70 cm	-	64,30
883080	8423545053355	80 cm	-	69,66
883090	8423545065686	90 cm	-	75,02
883100	8423545053362	100 cm	-	80,38

**M-H 2"-2" / M-F 2"-2" / M-F 2"-2"**  
ø Int. 50 mm

CÓDIGO	CÓDIGO EAN	ARTÍCULO	BOLSA/CAJA	PRECIO (€)
885030	8423545053454	30 cm	-	74,94
885040	8423545053461	40 cm	-	86,21
885050	8423545053478	50 cm	-	97,48
885060	8423545053485	60 cm	-	108,75
885070	8423545053492	70 cm	-	119,99
885080	8423545065709	80 cm	-	131,29
885090	8423545065716	90 cm	-	144,00
885100	8423545058794	100 cm	-	153,83

**Flexibles Galvanisés Pompe d'Eau / Water Pump Galvanized Hoses / Conexiones Galvanizadas Bomba de Agua**

**Set Flexibles Inox Robinetterie / Stainless Steel Hoses Tap Set / Juego Conexiones Inox Grifería**

**F 3/8"-10/100 / F 3/8"-10/100 / H 3/8"-10/100**  
ø Int. 8,3 mm ø Ext. 12,1 mm.

CÓDIGO	CÓDIGO EAN	ARTÍCULO	BOLSA/CAJA	PRECIO (€)
869003	8423545074794	3/8" 30 cm	2	8,46



Pression 16 bars / Pressure 16 bars / Presión 16 bars  
-10°C a + 90°C Temp.

# Gr<sup>03</sup>

## Grifería Faucets *Robinetterie*

Fabricación bajo Norma EN-816 con latón según Normas EN12164, EN12165 y EN1982.  
Made under EN-816 Norm with brass under EN12164, EN12165 and EN1982 Norms.  
Fabrication sous Norme EN-816 avec laiton selon Normes EN12164, EN12165 et EN1982.

**Monomandos**  
*Mitigeurs / Mixers*



76

**Grifería Temporizada Regulable "Novo Tempus"**  
*Adjustable Timed Tap Ware "Novo Tempus"*  
*Robinetterie Temporisée Réglable "Novo Tempus"*



79

**Grifería Temporizada Pre-regulada "Tempus"**  
*Robinetterie Temporisée Pre-réglée "Tempus" / Pre-adjusted Timed Tap Ware "Tempus"*



81

**Fluxómetros**  
*Fluxometres / Flowmeters*



83

**Pedales**  
*Pédales / Pedal Taps*



84

**Grifería Variada**  
*Robinetterie Diverse / Assorted Taps*



85

**Grifos Lavadora**  
*Robinetterie pour Machine à Laver / Washing Machine Taps*



89

**Grifería Hospital**  
*Robinetterie pour Hôpital / Hospital Taps*



91

**Llaves Regulación**  
*Robinets d'Arrêt / Angle Valves*



92

**Monturas Grifo**  
*Têtes Universelles / Head taps*



93

**Complementos**  
*Compléments / Complements*



94

PRIMA



**Monomando Lavabo / Basin Mixer / Mitigeur Lavabo**

CÓDIGO	CÓDIGO EAN	ARTÍCULO	CAJA	PRECIO (€)
740010	8423545092590	-	1	69,42

**Monomando Lavabo con Maneta Abierta**

Basin Mixer with Open Handle / Mitigeur Lavabo avec Poignée Percée

CÓDIGO	CÓDIGO EAN	ARTÍCULO	CAJA	PRECIO (€)
740110	8423545093825	-	1	69,42

**Monomando Bidé / Bidet Mixer / Mitigeur Bidet**

CÓDIGO	CÓDIGO EAN	ARTÍCULO	CAJA	PRECIO (€)
740020	8423545092521	-	1	69,42

**Monomando Bidé con Maneta Abierta**

Bidet Mixer with Open Handle / Mitigeur Bidet avec Poignée Percée

CÓDIGO	CÓDIGO EAN	ARTÍCULO	CAJA	PRECIO (€)
740120	8423545093832	-	1	69,42

**Monomando Bañera / Bath Mixer / Mitigeur Baignoire**

CÓDIGO	CÓDIGO EAN	ARTÍCULO	CAJA	PRECIO (€)
740030	8423545092538	-	1	115,05

**Monomando Bañera con Maneta Abierta**

Bath Mixer with Open Handle / Mitigeur Baignoire avec Poignée Percée

CÓDIGO	CÓDIGO EAN	ARTÍCULO	CAJA	PRECIO (€)
740130	8423545093849	-	1	115,05

**Monomando Ducha / Shower Mixer / Mitigeur Douche**

CÓDIGO	CÓDIGO EAN	ARTÍCULO	CAJA	PRECIO (€)
740040	8423545092545	-	1	89,96

**Monomando Ducha con Maneta Abierta**

Shower Mixer with Open Handle / Mitigeur Douche avec Poignée Percée

CÓDIGO	CÓDIGO EAN	ARTÍCULO	CAJA	PRECIO (€)
740140	8423545093856	-	1	89,96

**Monomando Fregadera Vertical**

Kitchen Vertical Mixer Swivel Spout / Mitigeur Evier Vertical

CÓDIGO	CÓDIGO EAN	ARTÍCULO	CAJA	PRECIO (€)
740050	8423545092552	-	1	92,56

**Monomando Fregadera Vertical con Maneta Abierta / Kitchen Vertical Mixer Swivel Spout with Open Handle / Mitigeur Evier Vertical avec Poignée Percée**

CÓDIGO	CÓDIGO EAN	ARTÍCULO	CAJA	PRECIO (€)
740150	8423545093863	-	1	92,56

**Monomando Fregadera Horizontal**

Kitchen Horizontal Mixer Swivel Spout / Mitigeur Evier Horizontal

CÓDIGO	CÓDIGO EAN	ARTÍCULO	CAJA	PRECIO (€)
740060	8423545092569	-	1	72,80



PRIMA

**Monomando Fregadera Horizontal con Maneta Abierta**

Kitchen Horizontal Mixer Swivel Spout with Open Handle  
Mitigeur Evier Horizontal avec Poignée Percée

CÓDIGO	CÓDIGO EAN	ARTÍCULO	CAJA	PRECIO (€)
740160	8423545093870	-	1	72,80

**Mitigeur Evier Mural / Kitchen Wall Mixer Swivel Spout / Monomando Fregadera Mural**

CÓDIGO	CÓDIGO EAN	ARTÍCULO	CAJA	PRECIO (€)
740070	8423545092576	C/BAJO	1	97,50
740075	8423545100998	C/ALTO	1	129,74

**Monomando Fregadera Mural con Maneta Abierta**

Kitchen Wall Mixer Swivel Spout with Open Handle  
Mitigeur Evier Mural avec Poignée Percée

CÓDIGO	CÓDIGO EAN	ARTÍCULO	CAJA	PRECIO (€)
740170	8423545093887	-	1	97,50

**Monomando Fregadera con Ducha**

Pull-out Kitchen Mixer Swivel Spout / Mitigeur Evier avec Douchette

CÓDIGO	CÓDIGO EAN	ARTÍCULO	CAJA	PRECIO (€)
740080	8423545092583	-	1	129,74

**Monomando Fregadera con Ducha con Maneta Abierta**

Pull-out Kitchen Mixer Swivel Spout with Open Handle  
Mitigeur Evier avec Douchette Poignée Percée

CÓDIGO	CÓDIGO EAN	ARTÍCULO	CAJA	PRECIO (€)
740180	8423545093894	-	1	129,74



ZERO

**Mitigeur Lavabo / Basin Mixer / Monomando Lavabo**

CÓDIGO	CÓDIGO EAN	ARTÍCULO	CAJA	PRECIO (€)
740810	8423545092873	-	1	90,50

**Mitigeur Bidet / Bidet Mixer / Monomando Bidé**

CÓDIGO	CÓDIGO EAN	ARTÍCULO	CAJA	PRECIO (€)
740820	8423545092880	-	1	90,50

**Mitigeur Baignoire / Bath Mixer / Monomando Bañera**

CÓDIGO	CÓDIGO EAN	ARTÍCULO	CAJA	PRECIO (€)
740830	8423545092897	-	1	144,50

**Mitigeur Douche / Shower Mixer / Monomando Ducha**

CÓDIGO	CÓDIGO EAN	ARTÍCULO	CAJA	PRECIO (€)
740840	8423545092903	-	1	118,20



Monomandos / Mixers / Mitigeurs

ZERO



**Monomando Fregadera Vertical**  
Kitchen Vertical Mixer Swivel Spout / Mitigeur Evier Vertical

CÓDIGO	CÓDIGO EAN	ARTÍCULO	CAJA	PRECIO (€)
740850	8423545092910	-	1	84,70

**Monomando Fregadera Horizontal**  
Kitchen Horizontal Mixer Swivel Spout / Mitigeur Evier Horizontal

CÓDIGO	CÓDIGO EAN	ARTÍCULO	CAJA	PRECIO (€)
740860	8423545092927	-	1	87,60

METAL THERM



**Monomando Termostático Baño**  
Thermostatic Bath Mixer / Mitigeur Thérmostatique Baignoire

CÓDIGO	CÓDIGO EAN	ARTÍCULO	CAJA	PRECIO (€)
740930	8423545092934	-	1	210,60

**Monomando Termostático Ducha**  
Thermostatic Shower Mixer / Mitigeur Thérmostatique Douche

CÓDIGO	CÓDIGO EAN	ARTÍCULO	CAJA	PRECIO (€)
740940	8423545092941	-	1	185,90

Grifería Temporizada Regulable "Novo-Tempus"  
Robinetterie Temporisée Réglable "Novo-Tempus" / Adjustable Timed Tap Ware "Novo-Tempus"

**TEMPUS**

- Grifería temporizada pre-regulada
- Mecanismo de cierre automático.
- Compatible con la grifería NOVO-TEMPUS y otras.
- Pre-adjusted timed sanitary taps.
- Automatic stop mechanism.
- Mechanism interchangeable with NOVO-TEMPUS taps and others.
- Robinetterie temporisée pre-réglée
- Mécanisme de fermeture automatique.
- Compatibilité avec la robinetterie NOVO-TEMPUS et autres.

**NOVO - TEMPUS**

- Grifería temporizada regulable
- Mecanismo fácil de regulación a voluntad.
- Compatible con la grifería TEMPUS y otras.
- Adjustable timed sanitary taps.
- Stop mechanism with voluntary easy regulation.
- Mechanism interchangeable with TEMPUS taps and others.
- Robinetterie temporisée réglable.
- Mécanisme de facile réglage à volonté.
- Compatibilité avec la robinetterie TEMPUS et autres.

La Grifería Temporizada ha sido probada en nuestro laboratorio a 3 Kgs. (bars) de presión; los tiempos indicados son aproximados. The Timed Tap-Wares are tested in our laboratory to 3 kgs. (bars) of pressure; times indicated are approximate. Les Robinets Temporisés ont été testés en notre laboratoire à 3 kgs. (bars) de pression; les temps indiqués sont approximatifs.

Si se incrementa o disminuye la presión de trabajo (respecto a los 3 Kgs. con los que ha sido probada), tiene una incidencia directa en el tiempo de cierre y apertura (el tiempo de flujo de agua se incrementa o reduce en consecuencia). If we increase or decrease the work pressure (regarding the 3 kgs. that have been tested), there is a direct incidence in the closing and opening time (water flow's time increases or decreases accordingly). Si la pression de travail est augmentée ou diminuée (par rapport aux 3 kgs. du test effectué), il y a une répercussion directe en le temps d'ouverture et fermeture (le temps de débit d'eau s'incrémente ou se réduit en conséquence).

Siempre que nuestra Grifería Temporizada se instala en obra nueva, más aún si es una instalación colectiva, es necesario purgar las tuberías antes de instalar los grifos, ya que toda Grifería Temporizada es muy sensible a la suciedad, pudiendo repercutir en el correcto funcionamiento de la instalación (impidiendo un cierre correcto). Whenever our Timed Tap-Wares are installed in a new facility, even more if it's a collective installation, it is necessary to purge piping before placing the taps, since the whole range of Timed Tap-Wares is very sensitive to dirt, which may affect its proper operation (preventing a proper closure). Chaque fois que nos Robinets Temporisés s'installent en tout nouveau bâtiment, plus encore s'il s'agit d'une installation collective, il est nécessaire de purger les tubes avant d'installer les robinets, donc tous les Robinets Temporisés sont très sensibles à la saleté, pouvant affecter au correct fonctionnement de l'installation (empêchant une correcte fermeture).

Si se incrementa o disminuye la presión de trabajo (respecto a los 3 Kgs. con los que ha sido probada), tiene una incidencia directa en el tiempo de cierre y apertura (el tiempo de flujo de agua se incrementa o reduce en consecuencia). If we increase or decrease the work pressure (regarding the 3 kgs. that have been tested), there is a direct incidence in the closing and opening time (the water flow's time increases or decreases accordingly). Si la pression de travail est augmentée ou diminuée (par rapport aux 3 kgs. du test effectué), il y a une répercussion directe en le temps d'ouverture et fermeture (le temps de débit d'eau s'incrémente ou se réduit en conséquence).

Asimismo recordamos que, para toda instalación colectiva de Grifos Temporizados, consulten a nuestro Departamento Técnico en caso de cualquier duda. Likewise, for any collective installation of Timed Tap-Wares, we recommend to consult our Technical Department previously in case of any doubt. Nous recommandons aussi que, pour toute installation collective de Robinets Temporisés, veuillez consulter notre Service Technique dans le cas de quelque doute.

Grifería Temporizada Regulable "Novo-Tempus"  
Robinetterie Temporisée Réglable "Novo-Tempus" / Adjustable Timed Tap Ware "Novo-Tempus"

Robinet Temporisé Réglable Lavabo / Washbasin Adjustable Timed Tap / Grifo Temporizado Regulable Lavabo

Tête Bleu / Blue Head / Índice Azul

CÓDIGO	CÓDIGO EAN	ARTÍCULO	CAJA	PRECIO (€)
720300	8423545076255	1/2"	1	62,00

Tête Rouge / Red Head / Índice Rojo

CÓDIGO	CÓDIGO EAN	ARTÍCULO	CAJA	PRECIO (€)
720350	8423545062500	1/2"	1	62,00



Acabado Cromado  
Finition Chromé / Chromium-plated Finish

Robinet Temporisé Réglable Frontal / Adjustable Apparent Timed Tap / Grifo Temporizado Regulable Frontal

Finition Chromé / Chromium-plated Finish / Acabado Cromado

CÓDIGO	CÓDIGO EAN	ARTÍCULO	CAJA	PRECIO (€)
720100	8423545062333	1/2"	1	53,00

Finition Jaune Polie / Yellow Polished Finish / Acabado Amarillo Pulido

CÓDIGO	CÓDIGO EAN	ARTÍCULO	CAJA	PRECIO (€)
720500	8423545062371	1/2"	1	53,00



Tête Bleu / Blue Head / Índice Azul

### Grifería Temporizada Regulable "Novo-Tempus"

Robinetterie Temporisée Réglable "Novo-Tempus" / Adjustable Timed Tap Ware "Novo-Tempus"

#### Grifo Temporizado Regulable Escuadra / Adjustable Square Timed Tap / Robinet Temporisé Réglable Equerre



Acabado Cromado  
Chromium-plated Finish / Finition Chromé

##### Índice Azul / Blue Head / Tête Bleu

CÓDIGO	CÓDIGO EAN	ARTÍCULO	CAJA	PRECIO (€)
720205	8423545062531	1/2"	1	49,80

#### Grifo Temporizado Regulable Ducha-Urinario Empotrar

Adjustable Embed Urinary-Shower Timed Tap / Robinet Temporisé Réglable à Encastrer Urinoir-Douche



Acabado Cromado  
Chromium-plated Finish / Finition Chromé

##### Índice Azul / Blue Head / Tête Bleu

CÓDIGO	CÓDIGO EAN	ARTÍCULO	BOLSA	PRECIO (€)
720400	8423545062364	1/2"	1	51,00

##### Índice Rojo / Red Head / Tête Rouge

CÓDIGO	CÓDIGO EAN	ARTÍCULO	CAJA	PRECIO (€)
720450	8423545062920	1/2"	1	51,00

#### Grifo Temporizado Regulable Urinario-Ducha Visto

Adjustable Apparent Urinary-Shower Timed Tap / Robinet Temporisé Urinoir-Douche Apparent



Acabado Cromado  
Chromium-plated Finish / Finition Chromé

##### Índice Azul / Blue Head / Tête Bleu

CÓDIGO	CÓDIGO EAN	ARTÍCULO	CAJA	PRECIO (€)
720600	8423545062388	1/2"	1	57,40

#### Grifo Temporizado Regulable Urinario / Adjustable Urinary Timed Tap / Robinet Temporisé Réglable Urinoir



Acabado Cromado  
Chromium-plated Finish / Finition Chromé

##### Completo - Índice Azul / Complet - Blue Head / Complet - Tête Bleu

CÓDIGO	CÓDIGO EAN	ARTÍCULO	CAJA	PRECIO (€)
720200	8423545062340	1/2"	1	59,00

##### Bajante / Drain Pipe / Accessoire

CÓDIGO	CÓDIGO EAN	ARTÍCULO	BOLSA	PRECIO (€)
720210	8423545062487	1/2"	1	18,00

### Grifería Temporizada Regulable "Novo-Tempus"

Robinetterie Temporisée Réglable "Novo-Tempus" / Adjustable Timed Tap Ware "Novo-Tempus"

#### Tête Robinet Temporisé Réglable / Adjustable Timed Tap Head / Montura Grifo Temporizado Regulable

##### Tête Bleu / Blue Head / Índice Azul

CÓDIGO	CÓDIGO EAN	ARTÍCULO	CAJA	PRECIO (€)
720000	8423545062395	1/2"	1	30,50

##### Tête Rouge / Red Head / Índice Rojo

CÓDIGO	CÓDIGO EAN	ARTÍCULO	BOLSA	PRECIO (€)
720050	8423545062906	1/2"	1	30,50



Acabado Cromado  
Finition Chromé / Chromium-plated Finish

### Grifería Temporizada Pre-regulada "Tempus"

Robinetterie Temporisée Pre-réglée "Tempus" / Pre-adjusted Timed Tap Ware "Tempus"

#### Robinet Temporisé Pre-réglé Lavabo / Pre-adjusted Basin Timed Tap / Grifo Temporizado Pre-regulado Lavabo

##### Tête Bleu / Blue Head / Índice Azul

CÓDIGO	CÓDIGO EAN	ARTÍCULO	CAJA	PRECIO (€)
801300	8423545043615	1/2"	1	61,60

Pre-réglé à 20"sec. / Pre-adjusted to 20"sec. / Pre-regulado a 20 seg.

##### Tête Rouge / Red Head / Índice Rojo

CÓDIGO	CÓDIGO EAN	ARTÍCULO	BOLSA	PRECIO (€)
801600	8423545043660	1/2"	1	61,60

Pre-réglé à 20"sec. / Pre-adjusted to 20"sec. / Pre-regulado a 20 seg.



Acabado Cromado  
Finition Chromé / Chromium-plated Finish

#### Robinet Temporisé Pre-réglé Frontal / Pre-adjusted Apparent Timed Tap / Grifo Temporizado Pre-regulado Frontal

##### Finition Chromé / Chromium-plated Finish / Acabado Cromado

CÓDIGO	CÓDIGO EAN	ARTÍCULO	CAJA	PRECIO (€)
804100	8423545043738	1/2"	1	52,50

Pre-réglé à 20"sec. / Pre-adjusted to 20"sec. / Pre-regulado a 20 seg.

##### Finition Jaune Polie / Yellow Polished Finish / Acabado Amarillo Pulido

CÓDIGO	CÓDIGO EAN	ARTÍCULO	CAJA	PRECIO (€)
804500	8423545043776	1/2"	1	52,50

Pre-réglé à 20 sec. / Pre-adjusted to 20 sec. / Pre-regulado a 20 seg.



Tête Bleu / Blue Head / Índice Azul

**Grifería Temporizada Pre-regulada "Tempus"**  
 Robinetterie Temporisée Pre-réglée "Tempus" / Pre-adjusted Timed Tap Ware "Tempus"

**Grifo Temporizado Pre-regulado Ducha-Urinario Empotrar**

Pre-adjusted Embed Urinary-Shower Timed Tap / Robinet Temporisé Pre-réglé à Encastrer Urinoir-Douche



Acabado Cromado  
 Chromium-plated Finish / Finition Chromé

**Ducha Índice Azul / Blue Head Shower / Douche Tête Bleu**

CÓDIGO	CÓDIGO EAN	ARTÍCULO	CAJA	PRECIO (€)
805400	8423545043783	1/2"	1	50,11

Pre-regulado a 25 / 30 seg. / Pre-adjusted to 25 / 30 sec. / Pre-réglé à 25 / 30 sec.

**Urinario Índice Azul / Blue Head Urinary / Urinoir Tête Bleu**

CÓDIGO	CÓDIGO EAN	ARTÍCULO	CAJA	PRECIO (€)
802400	8423545043677	1/2"	1	50,11

Pre-regulado a 6 / 9 seg. / Pre-adjusted to 6 / 9 sec. / Pre-réglé à 6 / 9 sec.

**Grifo Temporizado Pre-regulado Urinario-Ducha Visto**

Pre-adjusted Apparent Urinary-Shower Timed Tap / Robinet Temporisé Urinoir-Douche Pre-réglé Apparent



Acabado Cromado  
 Chromium-plated Finish / Finition Chromé

**Ducha Índice Azul / Blue Head Shower / Douche Tête Bleu**

CÓDIGO	CÓDIGO EAN	ARTÍCULO	CAJA	PRECIO (€)
806600	8423545043806	1/2"	1	56,60

Pre-regulado a 25 / 30 seg. / Pre-adjusted to 25 / 30 sec. / Pre-réglé à 25 / 30 sec.

**Urinario Índice Azul / Blue Head Urinary / Urinoir Tête Bleu**

CÓDIGO	CÓDIGO EAN	ARTÍCULO	BOLSA	PRECIO (€)
806700	8423545043820	1/2"	1	56,60

Pre-regulado a 6 / 9 seg. / Pre-adjusted to 6 / 9 sec. / Pre-réglé à 6 / 9 sec.

**Grifo Temporizado Pre-regulado Urinario / Pre-adjusted Urinary Timed Tap / Robinet Pre-réglé Temporisé Urinoir**



Acabado Cromado  
 Chromium-plated Finish / Finition Chromé

**Completo Índice Azul / Blue Head Complet / Complet Tête Bleu**

CÓDIGO	CÓDIGO EAN	ARTÍCULO	CAJA	PRECIO (€)
803200	8423545043707	1/2"	1	58,20

Pre-regulado a 6 seg. / Pre-adjusted to 6 sec. / Pre-réglé à 6 sec.

**Bajante / Drain Pipe / Accessoire**

CÓDIGO	CÓDIGO EAN	ARTÍCULO	CAJA	PRECIO (€)
720210	8423545062487	1/2"	1	18,00

**Montura Grifo Temporizado Pre-regulado / Pre-adjusted Timed Tap Head / Tête Robinet Temporisé Pre-réglée**



Acabado Cromado  
 Chromium-plated Finish / Finition Chromé

**Índice Azul / Blue Head / Tête Bleu**

CÓDIGO	CÓDIGO EAN	ARTÍCULO	CAJA	PRECIO (€)
809100	8423545043943	6/9 sec.	1	29,00
809120	8423545043974	20 sec.	1	29,00
809130	8423545043981	25/30 sec.	1	29,00
809140	8423545044001	60 sec.	1	29,00

**Grifería Temporizada Pre-regulada "Tempus"**  
 Robinetterie Temporisée Pre-réglée "Tempus" / Pre-adjusted Timed Tap Ware "Tempus"

**Robinet Temporisé Pre-réglé Fontaine / Pre-adjusted Drinking Fountain Timed Tap / Grifo Fuente Pública**

**Finition Chromé / Chromium-plated Finish / Acabado Cromado**

CÓDIGO	CÓDIGO EAN	ARTÍCULO	CAJA	PRECIO (€)
807600	8423545043875	3/4"	1	75,90

Pre-réglé à 6 sec. / Pre-adjusted to 6 sec. / Pre-regulado a 6 seg.



**Finition Jaune Polie / Yellow Polished Finish / Acabado Amarillo Pulido**

CÓDIGO	CÓDIGO EAN	ARTÍCULO	CAJA	PRECIO (€)
807500	8423545043844	3/4"	1	75,50

Pre-réglé à 6 sec. / Pre-adjusted to 6 sec. / Pre-regulado a 6 seg.

**Fluxometres / Flowmeters / Fluxómetros**

**Fluxometre WC Horizontal Apparent / Front Horizontal WC Flowmeter / Fluxómetro WC Visto Horizontal**

CÓDIGO	CÓDIGO EAN	ARTÍCULO	CAJA	PRECIO (€)
667310	8423545036341	3/4"	1	89,20
667410	8423545036389	1"	1	95,50



**Fluxometre WC à Encastrer / Embed WC Flowmeter / Fluxómetro WC Empotrar**

CÓDIGO	CÓDIGO EAN	ARTÍCULO	CAJA	PRECIO (€)
667300	8423545036334	3/4"	1	89,20
667400	8423545036365	1"	1	95,50



**Montura Fluxómetro Pre-regulada / Tête Fluxometre Pre-réglé / Pre-adjusted Flowmeter Tap Head**

CÓDIGO	CÓDIGO EAN	ARTÍCULO	CAJA	PRECIO (€)
667005	8423545036297		1	50,90

Salida tubo / Exit pipe / Sortie tube: 3/4" = ø 25  
 Salida tubo / Exit pipe / Sortie tube: 1" = ø 30

**Tube Télescopique pour Fluxometre WC / Telescopic Tube for WC Flowmeter / Tubo Telescópico Descarga Fluxómetro**

CÓDIGO	CÓDIGO EAN	ARTÍCULO	CAJA	PRECIO (€)
667028	8423545036303	Ø 25 mm	1	43,50
667032	8423545036310	Ø 30 mm	1	45,70

Largo / Length / Longueur: 600 / 800 x 200 mm



Pedales / Pedal Taps / Pédales

**Mezclador Doble Pedal Horizontal** / Horizontal Double Pedal Mixer / *Mélangeur Double Pédale Horizontale*

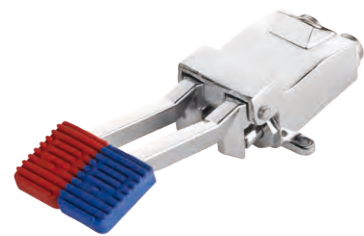

**Agua Fría-Caliente** / Cold-Hot Water / *Eau Froide-Chaude*

CÓDIGO	CÓDIGO EAN	ARTÍCULO	CAJA	PRECIO (€)
667100	8423545068823	1/2"	1	210,00

**Grifo Pedal Horizontal** / Horizontal Pedal Tap / *Robinet Pédale Horizontale*



**Agua Fría** / Cold Water / *Eau Froide*

CÓDIGO	CÓDIGO EAN	ARTÍCULO	CAJA	PRECIO (€)
665100	8423545035917	1/2"	1	119,00

**Mezclador Pedal Horizontal** / Horizontal Pedal Mixer / *Mélangeur Pédale Horizontale*



**Agua Fría-Caliente** / Cold-Hot Water / *Eau Froide-Chaude*

CÓDIGO	CÓDIGO EAN	ARTÍCULO	CAJA	PRECIO (€)
666100	8423545036273	1/2"	1	140,00

**Grifo Pedal Vertical** / Vertical Pedal Tap / *Robinet Pédale Verticale*



**Agua Fría** / Cold Water / *Eau Froide*

CÓDIGO	CÓDIGO EAN	ARTÍCULO	CAJA	PRECIO (€)
665200	8423545035924	1/2"	1	301,44

Pédales / Pedal Taps / Pedales

**Commande à Pied par Membrane** / Foot Push Button "Tempus" / **Pulsador de Pie "Tempus"**

*Laiton Chromé / Chromium-Plated Brass / Latón Cromado*

CÓDIGO	CÓDIGO EAN	ARTÍCULO	CAJA	PRECIO (€)
810800	8423545044407	Ø 10mm	1	98,50



**Montura Grifo Temporizado Pre-regulada**  
*Tête Robinet Temporisé Pre-réglé / Pre-adjusted Timed Tap Head*

CÓDIGO	CÓDIGO EAN	ARTÍCULO	CAJA	PRECIO (€)
810810	8423545044506		1	32,10

*Robinetterie Diverse / Assorted Taps / Grifería Variada*

*Robinet Temporisé Fontaine / Drinking Fountain Timed Tap / Grifo Fuente Pública*

*Poli / Polish / Pulido*

CÓDIGO	CÓDIGO EAN	ARTÍCULO	CAJA	PRECIO (€)
651002	8423545035467	1/2"	15	61,50
651003	8423545035474	3/4"	10	67,00
651004	8423545035481	1"	1	74,80



*Chromé / Chromium-Plated / Cromado*

CÓDIGO	CÓDIGO EAN	ARTÍCULO	CAJA	PRECIO (€)
652002	8423545035498	1/2"	15	72,20
652003	8423545035504	3/4"	10	129,21
652004	8423545035511	1"	1	136,00

*Robinet Fontaine Verticale / Vertical Drinking Fountain / Grifo Fuente Vertical*

*Chromé / Chromium-Plated / Cromado*

CÓDIGO	CÓDIGO EAN	ARTÍCULO	CAJA	PRECIO (€)
650011	8423545035450	3/8"	1	64,00
650111	8423545068564	MONTURA	1	31,25
650121	8423545081969	SURTIDOR	1	3,40



Grifería Variada / Assorted Taps / Robinetterie Diverse

Bebedero para Cerdos / Pigs Drinker / Robinet pour Cochons



CÓDIGO	CÓDIGO EAN	ARTÍCULO	CAJA	PRECIO (€)
965002	8423545057445	1/2"	20	5,49

Grifo Codo Presión / Pressure Elbow Tap / Robinet Puisse Simple



Pulido / Polished / Poli

CÓDIGO	CÓDIGO EAN	ARTÍCULO	CAJA	PRECIO (€)
460002	8423545023013	1/2"	1	15,14
460003	8423545023037	3/4"	1	22,10

Cromado / Chromium-Plated / Chromé

CÓDIGO	CÓDIGO EAN	ARTÍCULO	CAJA	PRECIO (€)
460012	8423545023075	1/2"	1	16,47
460013	8423545023082	3/4"	1	23,43

Grifo Codo Manguera / Garden Hose Pressure Tap / Robinet Puisse avec Raccord au Nez



Pulido / Polished / Poli

CÓDIGO	CÓDIGO EAN	ARTÍCULO	CAJA	PRECIO (€)
461002	8423545023181	1/2"	1	16,35
461003	8423545023204	3/4"	1	24,84

Cromado / Chromium-Plated / Chromé

CÓDIGO	CÓDIGO EAN	ARTÍCULO	CAJA	PRECIO (€)
461012	8423545023259	1/2"	1	17,60
461013	8423545023266	3/4"	1	26,10

Grifo Codo "Balear" / Elbow Pressure Tap "Balear" / Robinet Equerre Pession "Balear"



CÓDIGO	CÓDIGO EAN	ARTÍCULO	CAJA	PRECIO (€)
461902	8423545023297	1/2"	1	83,20

Con Florón / With tail piece / Avec rosace

Robinetterie Diverse / Assorted Taps / Grifería Variada

Robinet d'Arrêt Piston / Push Button Stopcock / Grifo Paso Pistón

CÓDIGO	CÓDIGO EAN	ARTÍCULO	CAJA	PRECIO (€)
746002	8423545041338	1/2"	1	35,80



Tête Robinet / Tap Head / Montura

CÓDIGO	CÓDIGO EAN	ARTÍCULO	CAJA	PRECIO (€)
746010	8423545041352		1	23,45

Robinet Evier "Pioner" / Sink Tap "Pioner" / Grifo Fregadera "Pioner"

Longeur 12 cm. / 12 cm. Long / Largo 12 cm.

CÓDIGO	CÓDIGO EAN	ARTÍCULO	CAJA	PRECIO (€)
818214	8423545045091	1/2"x14 V/ABS	2	20,78
818412	8423545045114	1/2"x14 V/METAL	1	24,05



Robinet Lavabo / Basin Tap / Grifo Lavabo

CÓDIGO	CÓDIGO EAN	ARTÍCULO	CAJA	PRECIO (€)
816100	8423545044865	1/2" ABS	2	26,05



Robinet Tournant Evier / Turning Sink Tap / Grifo Giratorio Fregadera

Bec Haut Chromé / Chromium-Plated High Faucet / Caño Alto Cromado

CÓDIGO	CÓDIGO EAN	ARTÍCULO	CAJA	PRECIO (€)
701550	8423545038666	1/2" Metal	2	49,40



Grifería Variada / Assorted Taps / Robinetterie Diverse

Caño Giratorio Fregadera Tubo / Washbasin Swivel Pipe / Tube Bec Orientable Evier



Caño Bajo Cromado / Chromium-plated Low Faucet / Bec Bas Chromé

CÓDIGO	CÓDIGO EAN	ARTÍCULO	CAJA	PRECIO (€)
668150	8423545036419	1/2"	1	78,00

Caño Giratorio Vertical / Vertical Turning Sink Tap / Bec Vertical Orientable



CÓDIGO	CÓDIGO EAN	ARTÍCULO	CAJA	PRECIO (€)
665700	8423545035931	1/2"	1	85,28

Atomizador Cromado / Chromium-plated Water Sprayer / Atomiseur Chromé



CÓDIGO	CÓDIGO EAN	ARTÍCULO	CAJA	PRECIO (€)
701050	8423545038529	22/100 H	40	1,76
701054	8423545038543	24/100 M	40	1,93

**65%** Ahorra Agua / Save Water / Economie de l'Eau

Atomizador Rótula Cromado / Chromium-Plated Knee Water Sprayer / Atomiseur Rotule Chromé



CÓDIGO	CÓDIGO EAN	ARTÍCULO	CAJA	PRECIO (€)
704322	8423545038987	22/100 H	20	5,30
704324	8423545038994	24/100 M	20	5,65

**65%** Ahorra Agua / Save Water / Economie de l'Eau

Robinetterie Machine à Laver / Washing Machine Taps / Grifos Lavadora

Robinet Machine à Laver 1/2"-3/4" / 1/2"-3/4" Washing Machine Tap / Grifo Lavadora 1/2"-3/4"

CÓDIGO	CÓDIGO EAN	ARTÍCULO	CAJA	PRECIO (€)
811002	8423545044520	1/2" V/ABS	2	11,49
811012	8423545044544	1/2" V/METAL	2	12,99



Robinet Double Machine à Laver 1/2"-3/4" / 1/2"-3/4" Washing Machine Double Tap / Grifo Lavadora Doble 1/2"-3/4"

CÓDIGO	CÓDIGO EAN	ARTÍCULO	CAJA	PRECIO (€)
813002	8423545044742	1/2" V/ABS	2	25,77
813012	8423545044766	1/2" V/METAL	2	32,14



Robinet Equerre Machine à Laver / Washing Machine Ball Angle Valve / Grifo Esfera Angular para Lavadora

CÓDIGO	CÓDIGO EAN	ARTÍCULO	CAJA	PRECIO (€)
821940	8423545090688	1/2"-3/4"	1	8,90



Robinet Machine à Laver / Washing Machine Ball Valve / Grifo Esfera Intermedio para Lavadora

CÓDIGO	CÓDIGO EAN	ARTÍCULO	CAJA	PRECIO (€)
821920	8423545090671	1/2"-3/4"-1/2"	1	8,99



**Grifos Lavadora / Washing Machine Taps / Robinetterie Machine à Laver**

**Grifo Escuadra para Lavadora con Florón / Washing Machine Angle Tap with Tail Piece / Robinet Machine à Laver avec Rosace**



CÓDIGO	CÓDIGO EAN	ARTÍCULO	CAJA	PRECIO (€)
811032	8423545105863	1/2"x3/4" V/ABS	2	7,80

**Grifo Lavavajillas 1/2"-3/4" / 1/2"-3/4" Dishwasher Machine Tap / Robinet Lave-vaisselle 1/2"-3/4"**



CÓDIGO	CÓDIGO EAN	ARTÍCULO	CAJA	PRECIO (€)
815100	8423545044834	1/2" V/ABS	1	25,64
815110	8423545044841	1/2" V/METAL	1	31,90

**Conjunto Grifo Adaptador Lavavajillas / Dishwasher Machine Tap Adapter Set / Set Robinet Adaptateur Lave-vaisselle**



CÓDIGO	CÓDIGO EAN	ARTÍCULO	CAJA	PRECIO (€)
817003	8423545044940	V/METAL	1	22,25
817013	8423545044957	V/ABS	1	21,50

**Alargadera / Extension Piece / Allonge**

CÓDIGO	CÓDIGO EAN	ARTÍCULO	CAJA	PRECIO (€)
376304	8423545020920	3/4"x4 cm	1	7,23

**Flexo Plástico Entrada Lavadora / Inlet Washing Machine Plastic Hose / Flexible Plastique Entrée Machine à Laver**



**Tuerca ABS / ABS Nut / Ecrou ABS**

CÓDIGO	CÓDIGO EAN	ARTÍCULO	CAJA	PRECIO (€)
922015	8423545054895	1,50 m	1	4,84
922020	8423545054918	2,00 m	1	5,70

**Robinetterie Machine à Laver / Washing Machine Taps / Grifos Lavadora**

**Flexible Plastique Sortie Machine à Laver / Outlet Washing Machine Plastic Hose / Flexo Plástico Salida Lavadora**

CÓDIGO	CÓDIGO EAN	ARTÍCULO	CAJA	PRECIO (€)
922216	8423545054994	1,50 m	1	3,33

**Coude / Elbow / Codo**

CÓDIGO	CÓDIGO EAN	ARTÍCULO	CAJA	PRECIO (€)
922217	8423545092439	-	1	0,48



**Robinetterie pour Hôpital / Hospital Taps / Grifería Hospital**

**Robinet Vertical Lavabo 1/4 Tour / 1/4 Turn Basin Vertical Tap / Grifo Vertical Lavabo 1/4 Vuelta**

CÓDIGO	CÓDIGO EAN	ARTÍCULO	CAJA	PRECIO (€)
745102	8423545068847	1/2"	1	136,00



**Robinet Frontal 1/4 Tour / 1/4 Turn Frontal Tap / Grifo Frontal 1/4 Vuelta**

CÓDIGO	CÓDIGO EAN	ARTÍCULO	CAJA	PRECIO (€)
745302	8423545068861	1/2"	1	99,95



**Robinet Médical / Medical Tap / Grifo Medical**

CÓDIGO	CÓDIGO EAN	ARTÍCULO	CAJA	PRECIO (€)
745002	8423545041307	1/2"	1	125,00



Grifería Hospital / Hospital Taps / Robinetterie pour Hôpital

Grifo Frontal Giratorio 1/4 Vuelta / 1/4 Turn Swivel Frontal Tap / Robinet Frontal Orientable 1/4 Tour



CÓDIGO	CÓDIGO EAN	ARTÍCULO	CAJA	PRECIO (€)
745402	8423545068878	1/2"	1	125,00

Llaves Regulación / Angle Valves / Robinets d'Arrêt

Llave Regulación 1/4 Vuelta / 1/4 Turn Angle Valve / Robinet Arrêt Equerre 1/4 Tour



CÓDIGO	CÓDIGO EAN	ARTÍCULO	CAJA	PRECIO (€)
821901R	8423545113127	1/2"x3/8"	2	5,35
821902R	8423545114179	1/2"x1/2"	2	5,40

Grifo Regulación Esfera Tres Vías / Three Ways Angle Ball Tap / Robinet Arrêt Trois Sorties



CÓDIGO	CÓDIGO EAN	ARTÍCULO	CAJA	PRECIO (€)
821930	8423545090664	1/2"-3/4"-1/2"	1	10,00

Grifo Escuadra WC / Tank Tap / Robinet Arrêt Clapet Equerre



Pulido / Polish / Poli

CÓDIGO	CÓDIGO EAN	ARTÍCULO	CAJA	PRECIO (€)
621301	8423545060452	3/8"	10	8,80

Cromado / Chromium-plated / Chromé

CÓDIGO	CÓDIGO EAN	ARTÍCULO	CAJA	PRECIO (€)
621311	8423545059685	3/8"	10	9,45

Robinets d'Arrêt / Angle Valves / Llaves Regulación

Tête Universelle / Universal Tap Head / Montura Universal Vista

CÓDIGO	CÓDIGO EAN	ARTÍCULO	CAJA	PRECIO (€)
671001	8423545036433	3/8"	1	9,04
671002	8423545036440	1/2"	1	9,04
671016	8423545036457	16/150	1	9,04
671017	8423545036464	17/150	1	9,04
671018	8423545036488	18/150	1	9,04
671019	8423545036501	19/150	1	9,04
671020	8423545036525	20/150	1	9,04
671022	8423545036549	22/150	1	9,04



Tête Universelle à Encastrer / Embed Universal Tap Head / Montura Universal Empotrar

CÓDIGO	CÓDIGO EAN	ARTÍCULO	CAJA	PRECIO (€)
675001	8423545036884	3/8"	1	11,33
675002	8423545036891	1/2"	1	11,33
675016	8423545036907	16/150	1	11,33
675017	8423545036914	17/150	1	11,33
675018	8423545036938	18/150	1	11,33
675019	8423545036952	19/150	1	11,33
675020	8423545036976	20/150	1	11,33
675022	8423545036990	22/150	1	11,33



Tête Robinet Polie / Polish Tap Head / Montura Grifo Pulido

CÓDIGO	CÓDIGO EAN	ARTÍCULO	CAJA	PRECIO (€)
469017	8423545023709	17 mm	1	11,77
469018	8423545023716	18 mm	1	11,77
469019	8423545023723	19 mm	1	11,77
469022	8423545023754	22 mm	1	23,46



Complementos / Complements / Compléments

Compléments / Complements / Complementos

Florones / Tail Pieces / Rosaces

Ecrous Niquelés et Compléments / Nickeled Nuts and Complements / Tuercas Niqueladas y Complementos



(A)



(B)



(C)

Plano Inox / Plate Inox / Plate Inox (A)

CÓDIGO	CÓDIGO EAN	ARTÍCULO	CAJA	PRECIO (€)
841001	8423545048702	3/8"	100	0,35
841002	8423545048719	1/2"	100	0,35
841003	8423545068892	3/4"	100	0,35

Bombado Inox / Convex Inox / Bombé Inox (B)

CÓDIGO	CÓDIGO EAN	ARTÍCULO	CAJA	PRECIO (€)
841502	8423545086605	1/2"	100	0,35

Latón Pulido / Polished Brass / Laiton Poli (C)

CÓDIGO	CÓDIGO EAN	ARTÍCULO	CAJA	PRECIO (€)
841902	8423545062470	1/2"	100	1,10

Ecrous / Nuts / Tuercas

CÓDIGO	CÓDIGO EAN	ARTÍCULO	CAJA	PRECIO (€)
444110	8423545022368	3/8"x10,5	25	0,82
444210	8423545022382	1/2"x10	25	1,18
444212	8423545022399	1/2"x12	25	1,18
444214	8423545022412	1/2"x14	25	1,18

Rondelles / Washers / Arandelas

CÓDIGO	CÓDIGO EAN	ARTÍCULO	CAJA	PRECIO (€)
440110	8423545021927	3/8"x10,5	100	0,10
440210	8423545021934	1/2"x10	100	0,15
440212	8423545021941	1/2"x12	100	0,15
440214	8423545021958	1/2"x14	100	0,21

Joints Coniques / Conic Joints / Juntas Cónicas

CÓDIGO	CÓDIGO EAN	ARTÍCULO	CAJA	PRECIO (€)
449110	8423545022948	3/8"x10,5	100	0,14
449210	8423545022955	1/2"x10	100	0,16
449212	8423545022962	1/2"x12	100	0,16
449214	8423545022979	1/2"x14	100	0,16



Machones Monobloc / Monobloc Nipples / Raccords Union Monobloc



Normal / Standard / Normal

CÓDIGO	CÓDIGO EAN	ARTÍCULO	CAJA	PRECIO (€)
417201	8423545021750	1/2"x3/8"	25	2,19

Largo / Large / Long

CÓDIGO	CÓDIGO EAN	ARTÍCULO	CAJA	PRECIO (€)
417211	8423545021781	1/2"x3/8"	25	2,98

Codo / Elbow / Coude

CÓDIGO	CÓDIGO EAN	ARTÍCULO	CAJA	PRECIO (€)
417221	8423545021804	1/2"x3/8"	25	4,13

# Ba<sup>04</sup>

## Complementos de Baño Bathroom Complements *Accessoires Salle de Bain*

Fabricación bajo Norma EN-816 con latón según Normas EN12164, EN12165 y EN1982.  
Made with brass under EN-816 Norm under EN12164, EN12165 and EN1982 Norms.  
*Fabrication sous Norme EN-816 avec laiton selon Normes EN12164, EN12165 et EN1982.*

**Flexos de Ducha**  
*Shower Hoses / Flexibles Douche*



98

**Mangos de Ducha**  
*Hand Showers / Douchettes*



99

**Barras Deslizantes**  
*Sliding Rails / Barres Coulissantes*



103

**Brazos Ducha Pared**  
*Wall Showers / Becs Murals*



103

**Rociadores para brazos ducha**  
*Shower Roses / Pommes de Douche*



104

**Soportes de Ducha**  
*Shower Supports / Supports de Douche*



105

**Sifones Lavabo y Complementos**  
*WC Rubber Traps and Complements / Siphons Caoutchouc WC et Compléments*



107

**Juntas Moldeadas**  
*Mould Rubber Seals / Joints Moulés*



109

**Complementos de Baño**  
*Bathroom Complements / Accessoires Salle de Bain*



112

**Complementos Hierro Esmaltado**  
*Smalt Iron Complements / Accessoires Fer Émaillé*



114

Flexos de Ducha / Shower Hoses / Flexibles Douche

Flexo Inox Standard - Tuercas Grafiladas / Standard Inox Shower Hose - Graphiled Nuts / Flexible Inox Standard - Ecrous Moletés



CÓDIGO	CÓDIGO EAN	ARTÍCULO	BOLSA	PRECIO (€)
181055	8423545006856	1,50 m	1	9,26
181075	8423545006887	1,70 m	1	10,11
181085	8423545006900	2,00 m	1	10,94

Flexo Inox Standard - 1 Tuerca Cónica / Standard Inox Shower Hose - 1 Conic Nut / Flexible Inox Standard - 1 Ecrou Conique



CÓDIGO	CÓDIGO EAN	ARTÍCULO	BOLSA	PRECIO (€)
186455	8423545007402	1,50 m	1	9,49
186475	8423545007433	1,70 m	1	10,33
186485	8423545007457	2,00 m	1	11,31

Flexo Inox Reforzado - 1 Tuerca Cónica / Stronger Inox Shower Hose - 1 Conic Nut / Flexible Inox Renforcé - 1 Ecrou Conique



CÓDIGO	CÓDIGO EAN	ARTÍCULO	BOLSA	PRECIO (€)
186355	8423545007341	1,50 m	1	11,79
186375	8423545007365	1,70 m	1	12,63
186385	8423545007389	2,00 m	1	13,48

Flexo Inox Doble Engatillado - 1 Tuerca Cónica

Double Setting Inox Shower Hose - 1 Conic Nut / Flexible Inox Double Agrafage - 1 Ecrou Conique



CÓDIGO	CÓDIGO EAN	ARTÍCULO	BOLSA	PRECIO (€)
185085	8423545007303	1,75 m	1	12,63

Flexibles Douche / Shower Hoses / Flexos de Ducha

Flexible PVC - Ecrous Moletés / PVC Shower Hose - Graphiled Nuts / Flexo PVC - Tuercas Grafiladas



CÓDIGO	CÓDIGO EAN	ARTÍCULO	BOLSA	PRECIO (€)
188150 (A)	8423545009291	1,50 m	1	6,43
188153 (B)	8423545009352	1,50 m	1	6,43
188180 (A)	8423545009598	2,00 m	1	6,63
188183 (B)	8423545009659	2,00 m	1	6,63

Flexible PVC - 1 Ecrou Conique / PVC Shower Hose - 1 Conic Nut / Flexo PVC - 1 Tuerca Cónica



CÓDIGO	CÓDIGO EAN	ARTÍCULO	BOLSA	PRECIO (€)
188450 (A)	8423545010082	1,50 m	1	6,63
188453 (B)	8423545010143	1,50 m	1	6,63
188480 (A)	8423545010389	2,00 m	1	6,82
188483 (B)	8423545010440	2,00 m	1	6,82

Douchettes / Hand showers / Mangos de Ducha

Douchette "Cristin" / Hand Shower "Cristin" / Mango Ducha "Cristin"

Sans Coude / Without Elbow / Sin Codo

CÓDIGO	CÓDIGO EAN	ARTÍCULO	BOLSA/CAJA	PRECIO (€)
843900	8423545049150	BLANCO	1	2,31
843930	8423545049181	NEGRO	1	2,31



Monojet

Coude ABS / ABS Elbow / Codo ABS

CÓDIGO	CÓDIGO EAN	ARTÍCULO	BOLSA/CAJA	PRECIO (€)
845100	8423545049303	BLANCO	1	3,42
845130	8423545049334	NEGRO	1	3,42

Douchette "Lluvia" / Hand Shower "Lluvia" / Mando Ducha "Lluvia"

Coude ABS / ABS Elbow / Codo ABS

CÓDIGO	CÓDIGO EAN	ARTÍCULO	BOLSA	PRECIO (€)
845200	8423545049372	BLANCO	1	4,20
845230	8423545049389	NEGRO	1	4,20



Monojet

Mangos de Ducha / Hand Showers / Douchettes

Douchettes / Hand Showers / Mangos de Ducha

Mango Ducha "Elite" / Hand Shower "Elite" / Douchette "Elite"



Monojet

Sin Codo / Without Elbow / Sans Coude

CÓDIGO	CÓDIGO EAN	ARTÍCULO	BOLSA	PRECIO (€)
843600	8423545048993	BLANCO	1	2,10
843630	8423545049013	NEGRO	1	2,10

Codo ABS / ABS Elbow / Coude ABS

CÓDIGO	CÓDIGO EAN	ARTÍCULO	BOLSA	PRECIO (€)
845300	8423545049396	BLANCO	1	3,21
845330	8423545049419	NEGRO	1	3,21

Douchette "Club" / Hand Shower "Club" / Mango Ducha "Club"



Monojet

Sans Coude / Without Elbow / Sin Codo

CÓDIGO	CÓDIGO EAN	ARTÍCULO	BOLSA/CAJA	PRECIO (€)
844800	8423545064122	BLANCO	1	2,60
844830	8423545064139	NEGRO	1	2,60

Coude ABS / ABS Elbow / Codo ABS

CÓDIGO	CÓDIGO EAN	ARTÍCULO	BOLSA/CAJA	PRECIO (€)
845800	8423545064108	BLANCO	1	3,71
845830	8423545064115	NEGRO	1	3,71

Mango Ducha "Nina" / Hand Shower "Nina" / Douchette "Nina"



Monojet

Sin Codo / Without Elbow / Sans Coude

CÓDIGO	CÓDIGO EAN	ARTÍCULO	BOLSA	PRECIO (€)
842500	8423545086278	BLANCO	1	6,50
842550	8423545086285	CROMO	1	7,00

Douchette "Genesis" / Hand Shower "Genesis" / Mango Ducha "Genesis"



Monojet

Sans Coude / Without Elbow / Sin Codo

CÓDIGO	CÓDIGO EAN	ARTÍCULO	BOLSA	PRECIO (€)
843800	8423545049099	BLANCO	1	3,97
843830	8423545049112	NEGRO	1	3,97
843850	8423545049136	CROMO	1	8,08

Coude ABS / ABS Elbow / Codo ABS

CÓDIGO	CÓDIGO EAN	ARTÍCULO	BOLSA	PRECIO (€)
845400	8423545049440	BLANCO	1	5,08
845430	8423545049464	NEGRO	1	5,08
845450	8423545049488	CROMO	1	9,19

Mango Ducha "Sara" / Hand Shower "Sara" / Douchette "Sara"



Monojet

Sin Codo / Without Elbow / Sans Coude

CÓDIGO	CÓDIGO EAN	ARTÍCULO	BOLSA/CAJA	PRECIO (€)
842600	8423545086254	BLANCO	1	7,87
842650	8423545086261	CROMO	1	9,23

Douchette "Selene" / Hand Shower "Selene" / Mango Ducha "Selene"



3 positions / 3 positions / 3 posiciones

Sans Coude / Without Elbow / Sin Codo

CÓDIGO	CÓDIGO EAN	ARTÍCULO	BOLSA	PRECIO (€)
842200	8423545086292	BLANCO	1	13,78
842250	8423545086308	CROMO	1	14,69

Mangos de Ducha / Hand Showers / Douchettes

Mango Ducha "Yasmina" / Hand Shower "Yasmina" / Douchette "Yasmina"



Sin Codo / Without Elbow / Sans Coude

CÓDIGO	CÓDIGO EAN	ARTÍCULO	BOLSA/CAJA	PRECIO (€)
842300	8423545086315	BLANCO	1	16,00
842350	8423545086322	CROMO	1	17,55

3 posiciones / 3 positions / 3 positions

Mango Ducha "Noelia" / Hand Shower "Noelia" / Douchette "Noelia"



Sin Codo / Without Elbow / Sans Coude

CÓDIGO	CÓDIGO EAN	ARTÍCULO	BOLSA/CAJA	PRECIO (€)
842400	8423545086230	BLANCO	1	10,14
842450	8423545086247	CROMO	1	11,70

5 posiciones / 5 positions / 5 positions

Mango Ducha "Celtic" / Hand Shower "Celtic" / Douchette "Celtic"



Sin Codo / Without Elbow / Sans Coude

CÓDIGO	CÓDIGO EAN	ARTÍCULO	BOLSA/CAJA	PRECIO (€)
844400	8423545063996	BLANCO	1	13,00
844450	8423545063989	CROMO	1	14,56

3 posiciones / 3 positions / 3 positions

Mango Ducha "Hydra" / Hand Shower "Hydra" / Douchette "Hydra"



Sin Codo / Without Elbow / Sans Coude

CÓDIGO	CÓDIGO EAN	ARTÍCULO	BOLSA	PRECIO (€)
843320	8423545092095	CROMO	1	6,80

Monojet

Douchettes / Hand Showers / Mangos de Ducha

Douchette "Athenea" / Hand Shower "Athenea" / Mango Ducha "Athenea"

Sans Coude / Without Elbow / Sin Codo

CÓDIGO	CÓDIGO EAN	ARTÍCULO	BOLSA	PRECIO (€)
843420	8423545092101	CROMO	1	7,87



Monojet

Douchette "Zero" / Hand Shower "Zero" / Mango Ducha "Zero"

Douchette / Hand Shower / Mango Ducha

CÓDIGO	CÓDIGO EAN	ARTÍCULO	BOLSA	PRECIO (€)
845900	8423545086414	CROMO	1	10,43



Monojet

Barres Coulissantes / Sliding Rails / Barras Deslizantes

Barre Coulissante / Sliding Rail / Barra Deslizante

Zero Ø 18 mm / Zero Ø 18 mm / Zero Ø 18 mm

CÓDIGO	CÓDIGO EAN	ARTÍCULO	BOLSA/CAJA	PRECIO (€)
848300	8423545086452	CROMO 60 cm	1	70,00

Tigris Ø 18 mm / Tigris Ø 18 mm / Tigris Ø 18 mm

CÓDIGO	CÓDIGO EAN	ARTÍCULO	BOLSA/CAJA	PRECIO (€)
190700	8423545062760	BLANCA	1	19,37
190705	8423545062753	CROMO	1	20,65



Becs Murals / Wall Showers / Brazos Ducha Pared

Bec Mural Super "Skay" / Super Wall Shower "Skay" / Brazo Ducha Súper "Skay"

CÓDIGO	CÓDIGO EAN	ARTÍCULO	BOLSA	PRECIO (€)
842100	8423545048795	1/2" - 35 cm ø20mm	1	17,12



Brazos Ducha Pared / Wall Showers / Bec Murals

Brazo Ducha con Rótula "Pecho" / Wall Shower with Kneecap "Pecho" / Bec Mural avec Rotule "Pecho"



CÓDIGO	CÓDIGO EAN	ARTÍCULO	BOLSA	PRECIO (€)
837100	8423545048511	1/2" - 20 cm	1	48,37

Brazo Ducha "Pecho" / Wall Shower "Pecho" / Bec Mural "Pecho"



CÓDIGO	CÓDIGO EAN	ARTÍCULO	BOLSA	PRECIO (€)
837200	8423545048528	1/2" - 18 cm	1	30,17

Brazo Ducha "Pioner" / Wall Shower "Pioner" / Bec Mural "Pioner"



CÓDIGO	CÓDIGO EAN	ARTÍCULO	BOLSA	PRECIO (€)
838230	8423545048559	1/2" - 30 cm Ø 14 mm	1	14,71

Rociadores para Brazos de Ducha / Shower Roses / Pommes de Douche

Rociador Ducha con Rótula "Ital" / Shower Rose with Kneecap "Ital" / Pomme Douche avec Rotule "Ital"



CÓDIGO	CÓDIGO EAN	ARTÍCULO	BOLSA	PRECIO (€)
840102	8423545048610	1/2"	1	18,46

Rociador Plástico / Plastic Shower Rose / Pomme de Douche Plastique



CÓDIGO	CÓDIGO EAN	ARTÍCULO	BOLSA	PRECIO (€)
839002	8423545048580	1/2" Ø 53	1	1,20

Pommes de Douche / Shower Roses / Rociadores para Brazos de Ducha

Pomme de Douche "Skay" / Shower Rose "Skay" / Rociador "Skay"

CÓDIGO	CÓDIGO EAN	ARTÍCULO	BOLSA	PRECIO (€)
840302	8423545048641	1/2" Ø 90	1	4,91



Acier Inox / Stainless steel / Acero Inox

Pomme de Douche "Peque" / Shower Rose "Peque" / Rociador "Peque"

CÓDIGO	CÓDIGO EAN	ARTÍCULO	BOLSA	PRECIO (€)
840002	8423545048603	1/2" Ø 58	1	6,72



Laiton chromé / Chromium-plated Brass / Latón Cromado

Pomme Douche Antivandale / Anti Vandale Shower Rose / Rociador Ducha Antivandálico

CÓDIGO	CÓDIGO EAN	ARTÍCULO	BOLSA	PRECIO (€)
720960	8423545063644	1/2"	1	114,60



Supports de Douche / Shower Supports / Soportes de Ducha

Support Douche avec Rotule / Shower Support with Kneecap / Soporte Ducha con Rótula

Metalique / Metal / Metal

CÓDIGO	CÓDIGO EAN	ARTÍCULO	BOLSA	PRECIO (€)
849100	8423545049693	CROMO	1	6,73

ABS / ABS / ABS

CÓDIGO	CÓDIGO EAN	ARTÍCULO	BOLSA	PRECIO (€)
849125	8423545049723	CROMO	1	4,05



**Soportes de Ducha / Shower Supports / Supports de Douche**

**Soporte Ducha con Toma / Shower Support with Intake / Support Douche avec Prise**



CÓDIGO	CÓDIGO EAN	ARTÍCULO	BOLSA	PRECIO (€)
830100	8423545045657	1/2"	1	25,40

**Soporte Ducha "Podium" / Shower Support "Podium" / Support Douche "Podium"**



CÓDIGO	CÓDIGO EAN	ARTÍCULO	BOLSA	PRECIO (€)
849180	8423545049839	BLANCO / WHITE / BLANC	1	4,16
849183	8423545049853	NEGRO / BLACK / NOIR	1	4,16
849185	8423545049877	CROMO / CHROME / CHROMÉ	1	8,37

**Codo Mango Ducha / Hand-shower Brass Elbow / Coude Douchette**



**ABS / ABS / ABS**

CÓDIGO	CÓDIGO EAN	ARTÍCULO	BOLSA	PRECIO (€)
845999	8423545049563	1/2"	25	1,37

**Siphons Caoutchouc WC et Compléments / WC Rubber Traps and Complements / Sifones Lavabo y Complementos**

**Siphon Caoutchouc / Rubber Trap / Sifón de Goma**

**Mur Ouvert / Open Wall / Abierto Pared**

CÓDIGO	CÓDIGO EAN	ARTÍCULO	BOLSA	PRECIO (€)
961025	8423545057247	25/30 mm	30	4,94
961030	8423545027261	30/30 mm	30	4,94
961035	8423545057285	35/35 mm	30	4,94
961040	8423545069660	40/40 mm	25	5,33



**Sol Fermé / Closed Floor / Cerrado Suelo**

CÓDIGO	CÓDIGO EAN	ARTÍCULO	BOLSA	PRECIO (€)
963025	8423545057339	25/30 mm	30	5,33
963030	8423545057353	30/30 mm	30	5,33
963035	8423545057377	35/35 mm	30	5,33



**Evier Double / Double Sink / Fregadera Doble**

CÓDIGO	CÓDIGO EAN	ARTÍCULO	BOLSA	PRECIO (€)
962100	8423545057308	COMPLETO	1	16,66



**Siphon Laiton Chromé / Chromium-plated Brass Trap / Sifón Botella Cromado**

**Set Lavabo / Washbasin Set / Set Lavabo**

CÓDIGO	CÓDIGO EAN	ARTÍCULO	BOLSA	PRECIO (€)
965104	8423545057476	1"	1	57,43
965105	8423545057483	1" 1/4	1	57,08



**Set Bidet / Bidet Set / Set Bidé**

CÓDIGO	CÓDIGO EAN	ARTÍCULO	BOLSA	PRECIO (€)
966205	8423545057551	1" 1/4	1	37,44

Sifones Lavabo y Complementos / WC Rubber Traps and Complements / Siphons Caoutchouc WC et Compléments

Válvula Desagüe / Sink Drainvalve / Vidage Evier



Fregadera Plástico / Plastic Sink / Evier Plastique

CÓDIGO	CÓDIGO EAN	ARTÍCULO	BOLSA	PRECIO (€)
858430	8423545050170	30 mm	1	6,25
858435	8423545050194	35 mm	1	6,25

Lavabo Inox / Inox Basin / Lavabo Inox

CÓDIGO	CÓDIGO EAN	ARTÍCULO	BOLSA	PRECIO (€)
851004	8423545049921	1"	1	20,20
851005	8423545049938	1" 1/4	1	23,54



Cadena de Bolas Cromada / Chromium-plated Ball Chain / Chaînette Perlée Chromé



Metros / Meters / Mètres

CÓDIGO	CÓDIGO EAN	ARTÍCULO	BOBINA	PRECIO (€)
915032	8423545054680	Ø 3,2 mm (bobina 50 mts)	50	3,26
915040	8423545054697	Ø 4 mm (bobina 50 mts)	50	4,04



Juegos / Sets / Sets

CÓDIGO	CÓDIGO EAN	ARTÍCULO	BOLSA	PRECIO (€)
919032	8423545054789	25 cm Ø 3,2 mm	25	1,58
919040	8423545054802	45 cm Ø 4 mm	25	2,44

Siphons Caoutchouc WC et Compléments / WC Rubber Traps and Complements / Sifones Lavabo y Complementos

Accessoires pour Chaînette / Ball Chain Complements / Accesorios Cadena Bolas

CÓDIGO	CÓDIGO EAN	ARTÍCULO	BOLSA	PRECIO (€)
916177 (A)	8423545079348	"U" 3,2 mm	100	0,10
916178 (B)	8423545054703	LLAVERO	100	0,18
916179 (C)	8423545054727	"U" 4,0 mm	100	0,15
917112 (D)	8423545054741	ANILLA LLAVERO	100	0,18
918088 (E)	8423545054765	TRIANGULO TAPON GOMA	100	0,10

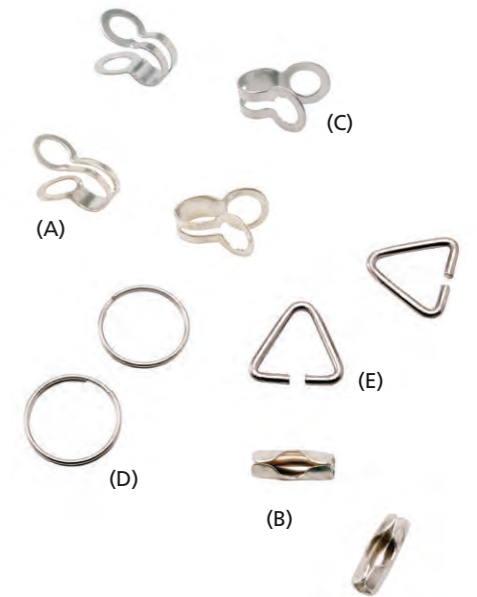

Joints Moulés / Mould Rubber Seals / Juntas Moldeadas

Joints Clapet / Closing Rubber Seals / Goma Válvulas Cierre

Plat / Flat / Plana

CÓDIGO	CÓDIGO EAN	ARTÍCULO	BOLSA	PRECIO (€)
935009	8423545055489	12 mm	100	0,10
935011	8423545055496	14 mm	100	0,11
935013	8423545055519	16 mm	100	0,11
935016	8423545055533	18 mm	100	0,14
935020	8423545055557	22 mm	100	0,16
935025	8423545055564	28 mm	100	0,18



Aveugle / Blind / Ciega

CÓDIGO	CÓDIGO EAN	ARTÍCULO	BOLSA	PRECIO (€)
936009	8423545055588	12 mm	100	0,10
936011	8423545055595	14 mm	100	0,11
936013	8423545055618	16 mm	100	0,12
936016	8423545055632	18 mm	100	0,14
936020	8423545055656	22 mm	100	0,16

Juntas Moldeadas / Mould Rubber Seals / Joints Moulés

Junta Goma Plana Normal / Normal Flat Rubber Joint / Joint Plat Normal Caoutchouc



CÓDIGO	CÓDIGO EAN	ARTÍCULO	BOLSA	PRECIO (€)
941001	8423545055779	3/8" - 10x15	100	0,08
941002	8423545055793	1/2" - 14x18,5	100	0,11
941003	8423545055816	3/4" - 18x23,5	100	0,12
941004	8423545055830	1" - 24x30	100	0,14
941005	8423545055847	1" 1/4 - 29,5x35	100	0,35
941006	8423545055854	1" 1/2 - 37x44	100	0,35
941007	8423545055861	2" - 50x56	100	0,36

Junta Goma Plana Ancha / Wide Flat Rubber Joint / Joint Plat Large Caoutchouc

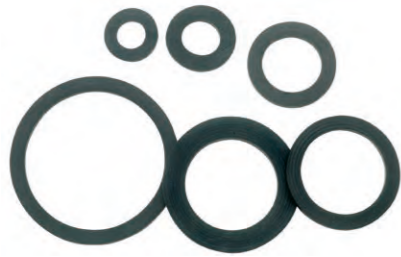

CÓDIGO	CÓDIGO EAN	ARTÍCULO	BOLSA	PRECIO (€)
941101	8423545055885	3/8" - 8x15	100	0,05
941102	8423545055908	1/2" - 10x18,5	100	0,08
941103	8423545055922	3/4" - 13x23,5	100	0,11
941104	8423545055946	1" - 20x30	100	0,17
941105	8423545055953	1" 1/4 - 28,5x37,5	100	0,23
941106	8423545055960	1" 1/2 - 30x44	100	0,32
941107	8423545055977	2" - 46x56	100	0,44

Junta Goma para Racor Macho "Barcelona"

Rubber Joint for Male Quick Connector "Barcelona" / Joint Caoutchouc pour Raccord Rapide Mâle Arrosage "Barcelona"



CÓDIGO	CÓDIGO EAN	ARTÍCULO	BOLSA	PRECIO (€)
940020	8423545055687	20 mm	1	0,43
940025	8423545055694	25 mm	1	0,32
940030	8423545055700	30 mm	1	0,35
940035	8423545055717	35 mm	1	0,68
940040	8423545055724	40 mm	1	0,81
940045	8423545055731	45 mm	1	0,91
940050	8423545055748	50 mm	1	0,98
940060	8423545055755	60 mm	1	2,11
940070	8423545055762	70 mm	1	2,12

Arandela Goma Moldeada / Mould Rubber Joint / Joint Caoutchouc Moulé



CÓDIGO	CÓDIGO EAN	ARTÍCULO	BOLSA	PRECIO (€)
932001	8423545055328	BIDÉ 3/8"	25	2,04
932002	8423545055342	BIDÉ 1/2"	25	1,11
932003	8423545055366	VÁLVULA 3/4"	25	1,11
932004	8423545055380	VÁLVULA 1"	25	1,11
933100	8423545055434	FREGADERA 1" 1/4	25	0,96
933200	8423545055441	BAÑO 1" 1/2	25	1,79
933300	8423545055465	DEPÓSITO 1" 1/4	25	1,33

Joints Moulés / Mould Rubber Seals / Juntas Moldeadas

Joint Plat Caoutchouc / Flat Rubber Joint / Arandela Goma Plana



CÓDIGO	CÓDIGO EAN	ARTÍCULO	BOLSA	PRECIO (€)
931001	8423545055205	3/8" 16x30	100	0,19
931002	8423545055229	1/2" 20x46	100	0,32
931003	8423545055243	3/4" 26x66	100	0,50
931004	8423545055267	1" 32x70	100	0,54
931005	8423545055281	1" 1/4 36x70	100	0,54
931006	8423545055304	1" 1/2 40x80	100	0,54

Joints Toriques / O-Rings / Juntas Tóricas

Section 1,78 / Section 1,78 / Sección 1,78

CÓDIGO	CÓDIGO EAN	ARTÍCULO	BOLSA	PRECIO (€)
942001	8423545055982	AN-01 Ø 6,46	100	0,06
942002	8423545055991	AN-02 Ø 7,24	100	0,06
942003	8423545056004	AN-03 Ø 8,03	100	0,06
942004	8423545056011	AN-04 Ø 8,84	100	0,06
942005	8423545056028	AN-05 Ø 9,63	100	0,06
942006	8423545056035	AN-06 Ø 11,21	100	0,07
942007	8423545056042	AN-07 Ø 12,81	100	0,07

Section 2,62 / Section 2,62 / Sección 2,62

CÓDIGO	CÓDIGO EAN	ARTÍCULO	BOLSA	PRECIO (€)
942008	8423545056059	AN-08 Ø 14,43	100	0,07
942009	8423545056066	AN-09 Ø 16,01	100	0,07
942010	8423545056073	AN-10 Ø 17,61	100	0,08
942011	8423545056080	AN-11 Ø 19,18	100	0,08
942012	8423545056097	AN-12 Ø 20,76	100	0,09
942013	8423545056103	AN-13 Ø 22,36	100	0,09
942014	8423545056110	AN-14 Ø 23,96	100	0,13

Section 3,53 / Section 3,53 / Sección 3,53

CÓDIGO	CÓDIGO EAN	ARTÍCULO	BOLSA	PRECIO (€)
942015	8423545056127	AN-15 Ø 25,70	100	0,12
942016	8423545056134	AN-16 Ø 27,28	100	0,13
942017	8423545056141	AN-17 Ø 28,88	100	0,14
942018	8423545056158	AN-18 Ø 30,45	100	0,15
942019	8423545056165	AN-19 Ø 32,05	100	0,17
942020	8423545056172	AN-20 Ø 33,63	100	0,19



Juntas Moldeadas / Mould Rubber Seals / Joints Moules

Junta Klingerit / Klingerit Joint / Joint Klingerit



Normal / Normal / Normal

CÓDIGO	CÓDIGO EAN	ARTÍCULO	BOLSA	PRECIO (€)
943001	8423545056257	3/8" - 10x14	100	0,07
943002	8423545056264	1/2" - 13x18	100	0,10
943003	8423545056271	3/4" - 18x23	100	0,14
943004	8423545056288	1" - 24x29	100	0,22
943005	8423545056295	1" 1/4 - 32x38	100	0,61
943006	8423545056301	1" 1/2 - 37x44	100	0,73
943007	8423545056318	2" - 47x54	100	0,89

Ancha / Wide / Large

CÓDIGO	CÓDIGO EAN	ARTÍCULO	BOLSA	PRECIO (€)
943101	8423545056325	3/8" - 8x14,5	100	0,10
943102	8423545056332	1/2" - 10x19	100	0,12
943103	8423545056349	3/4" - 16x24	100	0,16
943104	8423545056356	1" - 23x30	100	0,24
943105	8423545056363	1" 1/4 - 29x38	100	0,61
943106	8423545056370	1" 1/2 - 35x44	100	0,73
943107	8423545056387	2" - 44x55	100	0,89

Complementos de Baño / Bathroom Complements / Accessoires Salle de Bain

Tapón Goma Moldeada con Embellecedor Inox / Rubber Plug with Inox Top / Bouchon Caoutchouc avec Enjoliveur Inox



CÓDIGO	CÓDIGO EAN	ARTÍCULO	BOLSA	PRECIO (€)
949024	8423545056455	24 mm	25	0,93
949028	8423545056479	28 mm	25	0,93
949030	8423545056493	30 mm	25	0,98
949032	8423545056516	32 mm	25	0,98
949034	8423545056530	34 mm	25	1,05
949036	8423545056554	36 mm	25	1,05
949038	8423545056578	38 mm	25	1,13
949040	8423545056592	40 mm	25	1,16
949042	8423545056615	42 mm	25	1,20
949044	8423545056646	44 mm	25	1,30
949047	8423545056677	47 mm	25	1,40
949050	8423545056691	50 mm	25	1,71
949051	8423545056714	51 mm	25	1,71
949055	8423545056738	55 mm	25	1,76
949061	8423545056752	61 mm	25	1,86

Accessoires Salle de Bain / Bathroom Complements / Complementos de Baño

Bouchon Caoutchouc Multi-usage / Universal Rubber Plug / Tapón Goma Universal

Bouchon Multi-usage / Universal Rubber Stopper / Tapón Universal

CÓDIGO	CÓDIGO EAN	ARTÍCULO	BOLSA	PRECIO (€)
949144	8423545056776	44 mm	25	1,04



Cache-trou Bidet ou Lavabo / Bidet or Basin Hole Stopper / Tapaorificios Bidé o Lavabo

CÓDIGO	CÓDIGO EAN	ARTÍCULO	BOLSA	PRECIO (€)
925144	8423545055106	BIDÉ INOX.	25	1,82
925145	8423545055120	CIEGO CROMO	25	1,30
925146	8423545055144	CIEGO BLANCO	25	1,17



Teflon / Teflon / Teflón

CÓDIGO	CÓDIGO EAN	ARTÍCULO	BOLSA	PRECIO (€)
980031	8423545057957	12 m	10	0,49



Axe Papier WC / WC Paper Axel / Eje Portarrollos WC

CÓDIGO	CÓDIGO EAN	ARTÍCULO	BOLSA	PRECIO (€)
980033	8423545057995	-	25	0,73



Set Equerre Lavabo / Washbasin Square Set / Juego Escuadra Lavabo

CÓDIGO	CÓDIGO EAN	ARTÍCULO	BOLSA	PRECIO (€)
951100	8423545056790	1,5 mm	1	4,07



Complementos de Baño / Bathroom Complements / Accessoires Salle de Bain

Filtro Rejilla Urinario / Urinary Grill Filter / Filtre Grille Urinoir



CÓDIGO	CÓDIGO EAN	ARTÍCULO	BOLSA	PRECIO (€)
927065	8423545070444	INOX	25	1,87

Filtro Fregadera / Sink Filter / Filtre Evier



CÓDIGO	CÓDIGO EAN	ARTÍCULO	BOLSA	PRECIO (€)
927055	8423545055182	INOX	25	1,59

Complementos Hierro Esmaltado / Smalt Iron Complements / Compléments Fer Emailé

Campana Hierro Esmaltado / Smalt Iron Bell / Hotte Fer Emailé



CÓDIGO	CÓDIGO EAN	ARTÍCULO	BOLSA	PRECIO (€)
975100	8423545057810	10 cm	1	18,30

Cortavientos Hierro Esmaltado / Small Iron Smoke Hat / Chapeau Fer Emailé



CÓDIGO	CÓDIGO EAN	ARTÍCULO	BOLSA	PRECIO (€)
952010	8423545056813	10 cm	1	10,74
952011	8423545056820	11 cm	1	10,74
952012	8423545056837	12 cm	1	10,74

Soporte Contador Gas / Gas Meter Support / Support Compteur Gaz



CÓDIGO	CÓDIGO EAN	ARTÍCULO	BOLSA	PRECIO (€)
980070	8423545063958	21x11x16,5 cm	1	6,60

Compléments Fer Emailé / Smalt Iron Complements / Complementos Hierro Esmaltado

Grille Ventilation / Ventilation Grill / Rejilla Ventilación

Alu / Aluminium / Aluminio

CÓDIGO	CÓDIGO EAN	ARTÍCULO	BOLSA	PRECIO (€)
955015	8423545056844	15x15 cm	1	2,29

Alu Blanc / White Aluminium / Aluminio Blanco

CÓDIGO	CÓDIGO EAN	ARTÍCULO	BOLSA	PRECIO (€)
954017	8423545079409	17x17 cm	1	4,00

Plastique Blanc / White Plastic / Plástico Blanco

CÓDIGO	CÓDIGO EAN	ARTÍCULO	BOLSA	PRECIO (€)
955022	8423545063972	22x9,5 cm	1	5,20



Modelo homologado  
Modèle homologué / Certified model



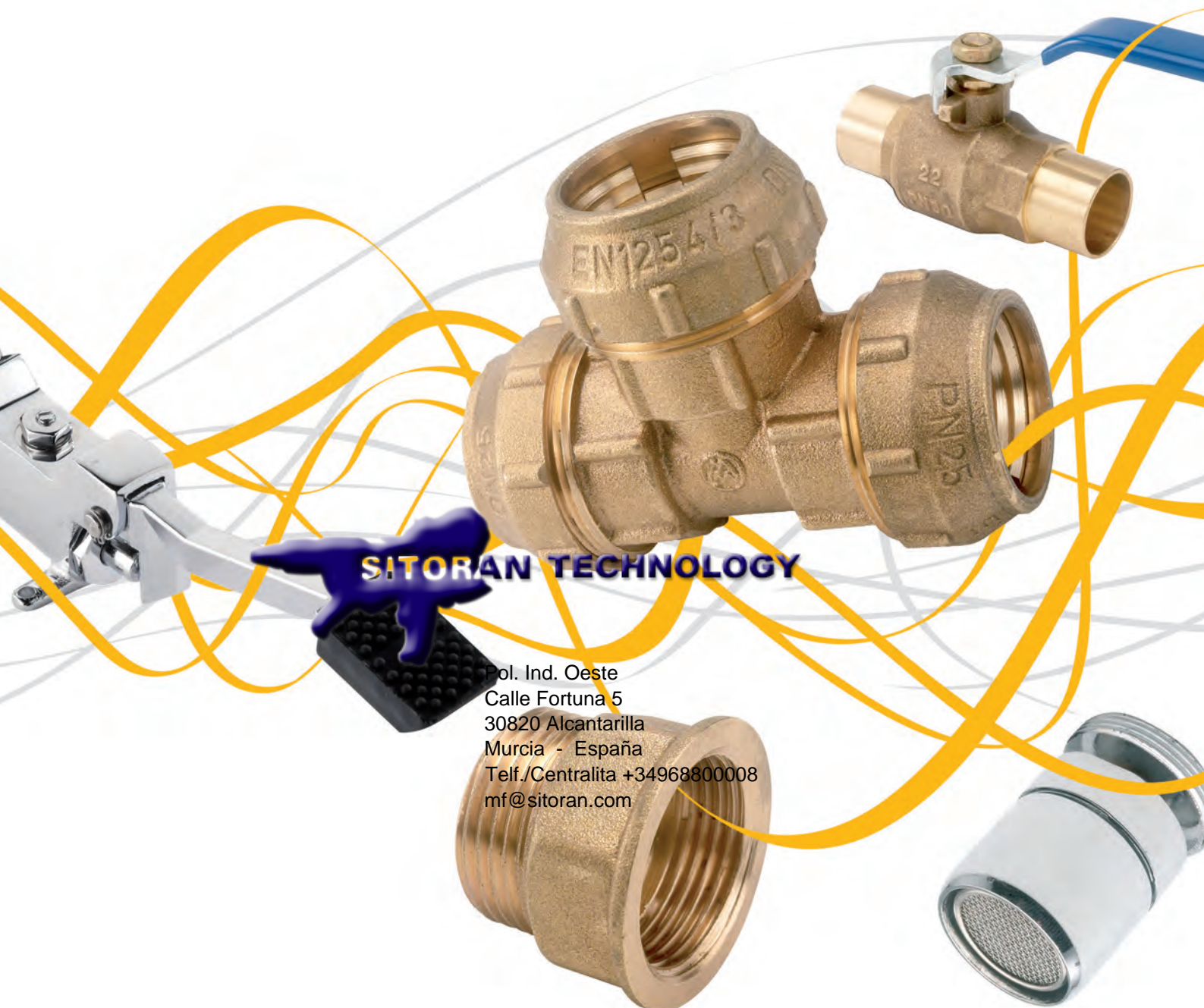

**SITORAN TECHNOLOGY**

Pol. Ind. Oeste  
Calle Fortuna 5  
30820 Alcantarilla  
Murcia - España  
Telf./Centralita +34968800008  
mf@sitoran.com