

SITORAN TECHNOLOGY EMPRESAS

CATALOGO

SANITARIOS

FossilNatura



FossilNatura
Sanitary Fashion

Una marca dinámica e innovadora orientada en crear elegantes ambientes en su baño. Desde su creación, Fossil Natura se ha centrado en la calidad, el diseño, la innovación y el servicio con una clara visión: reflexionar sobre nuestros espacios de vida y ofrecer constantemente productos de más alta calidad con lo último diseños y a los precios más asequibles.

Fossil Natura is a dynamic and innovative brand specialist of bath equipments. Since its creation, we have been focusing on quality, design, innovation and services with a clear vision: to rethink our living environments and to constantly deliver highest quality products with the latest designs and at the most affordable price.

GARANTÍA WARRANTY



• Todos nuestros productos han sido testados bajo un riguroso control de calidad, por ello, ofrecemos 5 años de garantía en la porcelana y 2 años tanto en mecanismos como en tapas.



• Todos nuestros modelos son compatibles 100% con repuestos existentes en el mercado.
• Todas nuestras series han sido testadas por el prestigioso fabricante de mecanismos Fominaya® confirmando la compatibilidad de nuestras series con sus mecanismos.

All our products have been produced under rigorous quality control, we offer 5 years warranty on porcelain and 2 years in both cistern fitting and slow down covers.

All our models are 100% compatible with existing parts in the market. All of our Toilets have been tested by the prestigious manufacturer of cistern fitting (Fominaya) confirming the compatibility of our series with its range of product.

WC



• Todos nuestros mecanismos disponen de descarga 3/6 litros para el ahorro del agua.

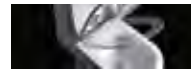

• Todas las tapas de nuestras series son con caída amortiguada.

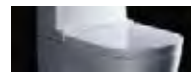

• Las superficies cerámicas están tratadas para su mayor higiene y fácil limpieza.

All our cistern fitting are provided with double flush cistern, 3/6 Liters for water saving.

All our covers are slow down.

The ceramic surfaces are treated for extra hygiene and easy cleaning.

BATHROOM
REVOLUTION
QUALITY
DESIGN
INNOVATION
SERVICES

CALIDAD

Nuestro objetivo es alcanzar la perfección de todos nuestros productos para garantizar la plena satisfacción de nuestros clientes. Para nosotros, la calidad no es sólo un objetivo, sino que es la clave de todo el proceso.

QUALITY

Our goal is to achieve perfection of all our products to ensure long lasting satisfaction of our customers. For Fossil Natura, quality is not merely a target; it is the key overwhelming concept throughout our organization.

INNOVACIÓN

Somos expertos en transformar los últimos conceptos en productos innovadores que respondan a las expectativas de los clientes más exigentes. Nos posicionamos como una marca innovadora que aporta originalidad en proyectos, técnicas, diseños y funciones al mercado internacional.

INNOVATION

We are experts at transforming latest concepts into breakthrough products that answer the expectations of the most demanding customers. We position ourselves as an innovative brand that brings breakthrough concepts, techniques, designs and functions to the international marketplace.

DISEÑO

Trabajamos con las últimas tendencias internacionales, nos centramos en formas modernas y materiales innovadores para crear estilos únicos que van a lo largo de los estilos de vida de hoy y las modas. Al igual que sus creadores, nuestros productos muestran personalidades fuertes y destacadas.

DESIGN

We work with the latest international trends, We focus on modern shapes, trendy colors and innovative materials to create unique styles that go along today's lifestyles and fashions. Like their creators, our products demonstrate strong and outstanding personalities.

SERVICIOS

También ofrecemos servicios a nuestros distribuidores y clientes finales, incluyendo: los servicios de nuestros productos (catálogos, folletos...), de nuestra marca (presencia en la web, campañas de promoción...), los servicios sobre el proceso de ventas (Merchandising tienda) y servicios sobre garantías de venta y postventa.

SERVICES

We also provide outstanding services to our distributors and end customer, including: services about our products (catalogues, brochures, flyers...); services about our brand (web presence, promotional campaigns, press...); services about the sales process (showroom display fixtures, store merchandising, product trainings...); and services about after sales (warranties and after sales support)



Praga



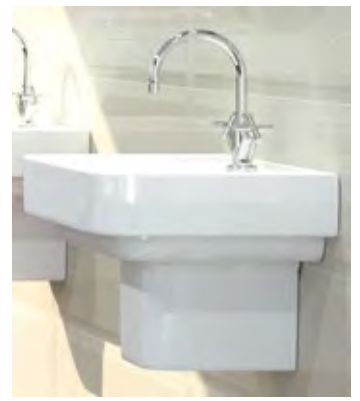

Ref. 100.20.00001VB
Ref. 100.20.00001VL

- Taza inodoro con evacuación horizontal.
- Codo completo de conversión a salida vertical.
- Entrada de agua inferior derecha R1/2".
- WC completo con salida posterior.
- Tanque con mecanismo completo economizador 3/6 l.
- Fijaciones a suelo multi-taladro.
- Fijaciones de asiento y tanque.
- Asiento ThermoDur con caída amortiguada.

Ref. 100.20.00002

- Bidé COMPLETO.
- Embelledor cromado en rebosadero.

Ref. 100.20.00003S

- Lavabo con semi pedestal.
- Embelledor cromado en rebosadero.

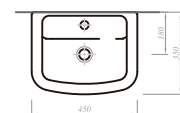
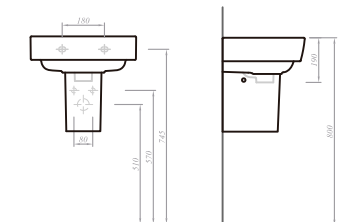
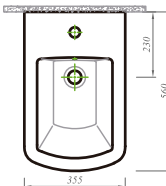
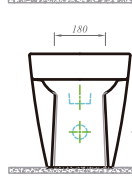
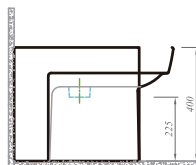
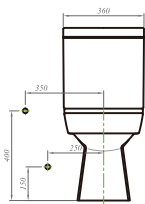
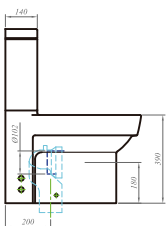



Empire suspendida



CISTERNA COLOR NEGRO



CISTERNA COLOR BLANCO

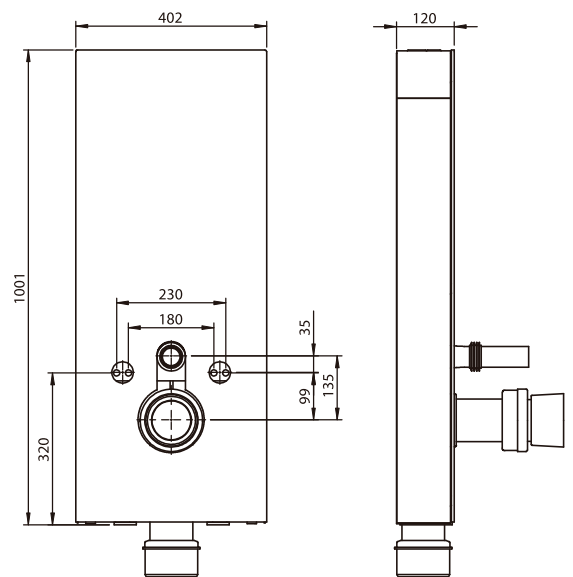

Ref. CVS01 (Cisterna vista BLACK para wc suspendido)
 Ref. CVS02 (Cisterna vista WHITE para wc suspendido)

Para taza suspendida .

Para rangos de presura de 0.3-16mm bar

Frontal cristal templado 6mm

Paneles laterales aluminio cepillado.

Facil y rápida instalacion

Muy elegante, tan solo 12cm grosor.

Doble descarga 3/6 litros

* INODORO NO INCLUIDO

Empire compacta



CISTERNA COLOR NEGRO



CISTERNA COLOR BLANCO

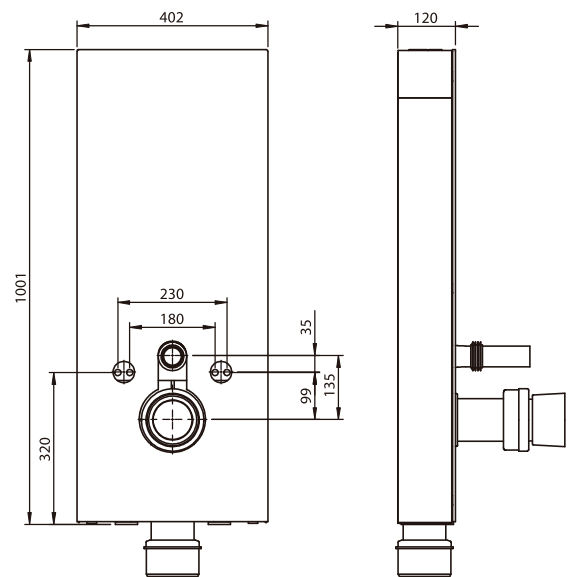

Ref. CVC01 (Cisterna vista BLACK para wc compacto)
Ref. CVC02 (Cisterna vista WHITE para wc compacto)

Para taza al suelo.

Para rangos de presión de 0.3-16mm bar

Frontal cristal templado 6mm

Paneles laterales aluminio cepillado.

Fácil y rápida instalación

Muy elegante, tan solo 12cm grosor.

Doble descarga 3/6 litros

* INODORO NO INCLUIDO



Génova



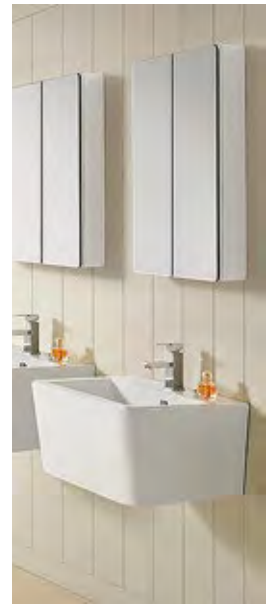

Ref. 100.20.00018
 Ref. 100.20.00018S (suspendido)
 Ref. 100.20.00018C (compacto)

- Taza inodoro con evacuación horizontal.
- Codo completo de conversión a salida vertical.
- Entrada de agua inferior der/izq (Taza)
- WC completo con salida dual.
- Tanque con mecanismo completo economizador 3/6 l.
- Fijaciones a suelo multi-taladro, de asiento y tanque.
- Asiento ThermoDur con caída amortiguada.
- Taza provista de agujeros laterales.

Ref. 100.20.00019
 Ref. 100.20.00019S (suspendido)

- Bidé completo.
- Fijaciones al suelo.
- Embelecedor cromado en rebosadero.

Ref. 100.20.00020S (suspendido)

- Lavabo suspendido.
- Embelecedor cromado en rebosadero.

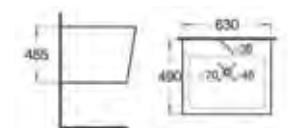
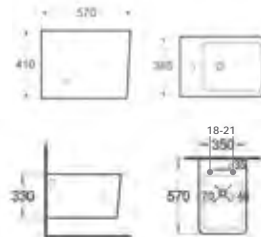
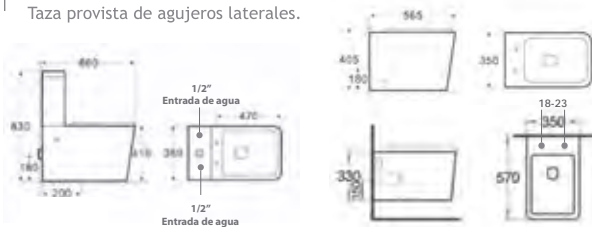



Bali





Ref. 100.20.00021
 Ref. 100.20.00021C (compacto)
 Ref. 100.20.00021S (suspendido)

- Taza inodoro con evacuación horizontal.
- Codo completo de conversión a salida vertical.
- Entrada de agua inferior derecha R1/2".
- WC completo con salida posterior.
- Tanque con mecanismo completo economizador 3/6 l.
- Fijaciones a suelo multi-taladro.
- Fijaciones de asiento y tanque.
- Asiento ThermoDur con caída amortiguada.

Ref. 100.20.00022

- Bidé COMPLETO.
- Embelledor cromado en rebosadero.

Ref. 100.20.00023

- Lavabo con pedestal.
- Embelledor cromado en rebosadero.

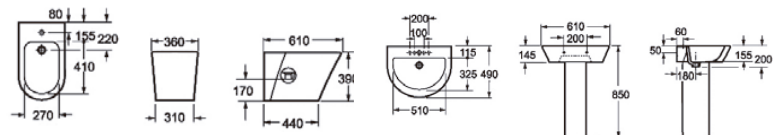
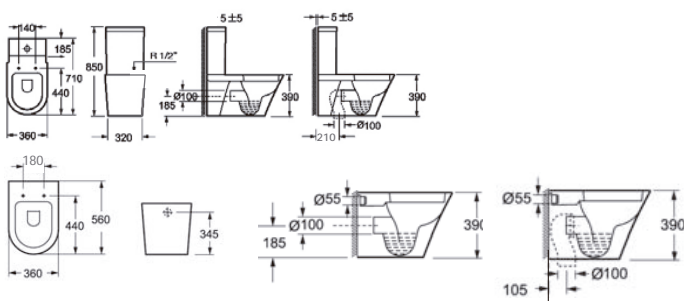



Atenas





Ref. 100.20.00030V (vertical)
Ref. 100.20.00030H (horizontal)

Taza inodoro con evacuación vertical/horizontal.

Entrada de agua inferior izquierda 1/2".

Tanque con mecanismo completo economizador 3/6l.

Fijaciones asiento y tanque.

Asiento ABS negro o blanco.

Asiento en madera color Nogal oscuro, Nogal claro, Blanco

lacado, Blanco rústico, caoba y wengé.

Ref. 100.20.00031

Bidé completo.

Fijaciones a suelo.

Embellededor cromado en rebosadero.

Ref. 100.20.00032

Lavabo con pedestal.

Fijaciones a suelo.

Embellededor cromado en rebosadero.

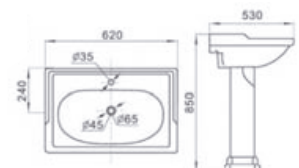
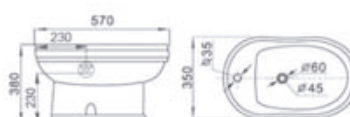
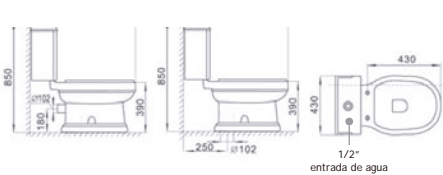



Venecia



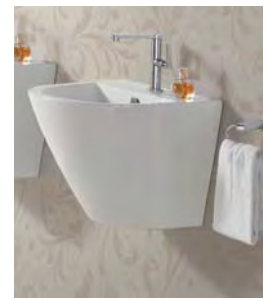

Ref. 100.20.00039

Taza inodoro con evacuación horizontal.

Codo completo de conversión a salida vertical.

Entrada de agua inferior der/izq 1/2" posterior

WC completo con salida dual.

Tanque con mecanismo completo economizador 3/6l.

Fijaciones a suelo multi-taladro, asiento y tanque.

Asiento ThermoDur con caída amortiguada.

Ref. 100.20.00040

Bidé completo.

Fijaciones al suelo.

Embellecedor cromado en rebosadero.

Ref. 100.20.00041S (suspendido)

Lavabo suspendido completo.

Embellecedor cromado en rebosadero.

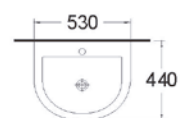
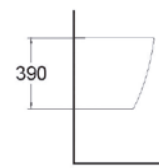
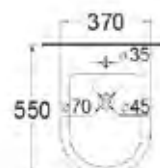
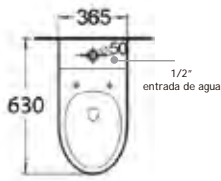
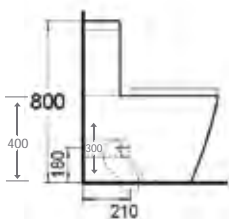



Verona



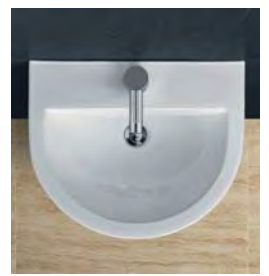

Ref. 100.20.00042G (grande)
 Ref. 100.20.00042P (pequeño)
 Ref. 100.20.00042S (suspensionado)

Taza inodoro con evacuación horizontal.
 Codo completo de conversión a salida vertical.
 Entrada de agua inferior der/izq 1/2" (taza)
 WC completo con salida dual.
 Taza provista de orificios laterales.
 Tanque con mecanismo completo economizador 3/6l.
 Fijaciones a suelo multi-taladro, asiento y tanque.
 Asiento ThermoDur con caída amortiguada.

Ref. 100.20.00043
 Ref. 100.20.00043S (suspensionado)

Bidé completo.
 Fijaciones al suelo.
 Embellecedor cromado en rebosadero.

Ref. 100.20.00041S (suspensionado)

Lavabo suspensionado completo.
 Embellecedor cromado en rebosadero.

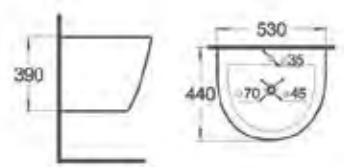
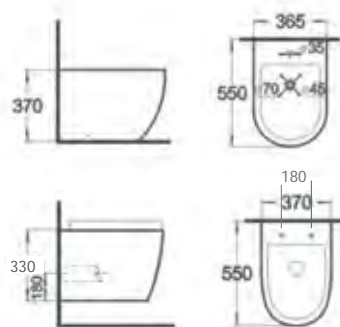
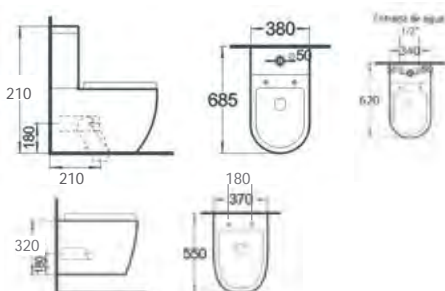



Verona Black



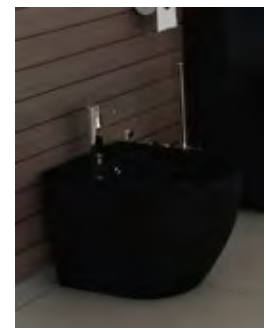

Ref. 100.20.00042B
 Ref. 100.20.00042BS (suspension)

Taza inodoro con evacuación horizontal.

Codo completo de conversión a salida vertical.

Entrada de agua inferior der/izq

WC completo con salida dual.

Taza provista de orificios laterales.

Tanque con mecanismo completo economizador 3/6l.

Fijaciones a suelo multi-taladro, asiento y tanque.

Asiento ThermoDur con caída amortiguada.

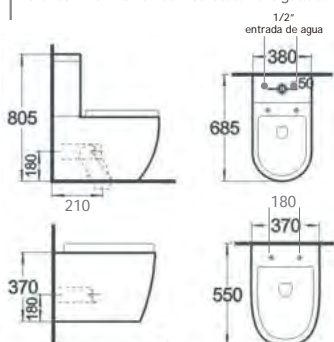

Ref. 100.20.00043B
 Ref. 100.20.00043BS (suspension).

Bidé completo.

Fijaciones al suelo.

Embellecedor cromado en rebosadero.

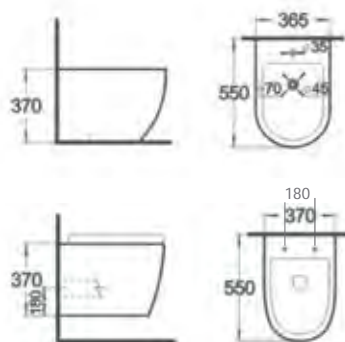

Ref. 100.20.00041BS (suspension)

Lavabo suspendido completo.

Embellecedor cromado en rebosadero.

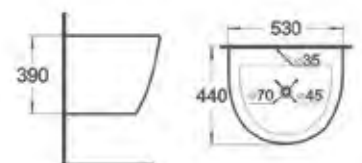



Oslo





- Ref. 100.20.00027V (vertical)
- Ref. 100.20.00027H (horizontal)
- Ref. 100.20.00027S (suspension)
- Ref. 100.20.00027MV (PMR vertical)
- Ref. 100.20.00027MH (PMR horizontal)

Taza inodoro con evacuación vertical/horizontal.

Entrada de agua izq/der.

Tanque con mecanismo completo economizador 3/6L.

Fijaciones al suelo, asiento y tanque.

Asiento ABS con caída amortiguada.

Salida horizontal en modelo suspendido.

Disponible modelo de inodoro PMR (personas con movilidad reducida).



- Ref. 100.20.00028
- Ref. 100.20.00028S (suspension)

Bidé completo.

Fijaciones al suelo.

Embelecedor cromado en rebosadero.

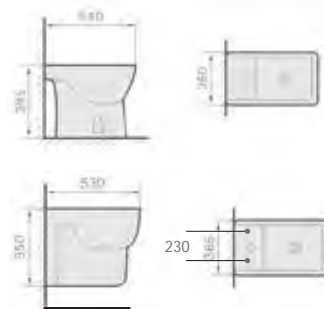

- Ref. 100.20.00029
- Ref. 100.20.00029S (semi-pedestal)

Lavabo con pedestal o semi-pedestal.

Tornillería.

Embelecedor cromado en rebosadero.





Niza





Ref. 100.20.00033V (vertical)
 Ref. 100.20.00033H (horizontal)
 Ref. 100.20.00033S (suspendido)

Taza inodoro con evacuación vertical/horizontal.
 Taza inodoro suspendido.
 Entrada de agua inferior o lateral de la cisterna.
 Tanque con mecanismo completo economizador 3/6l.
 Fijaciones a suelo/pared, asiento y tanque.
 Asiento ABS con caída amortiguada.
 Salida horizontal (suspendido).

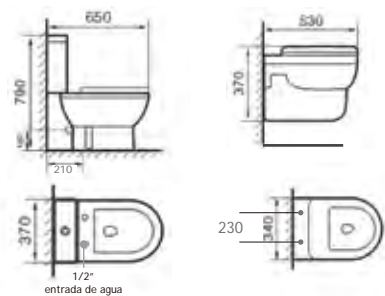

Ref. 100.20.00034

Bidé completo/suspendido.
 Fijaciones a suelo/pared.
 Embellecedor cromado en rebosadero.

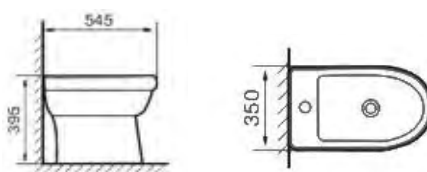

Ref. 100.20.00035
 Ref. 100.20.00035S (semipedestal)

Lavabo con pedestal/semipedestal.
 Fijaciones a pared con taco metálico a presión.
 Embellecedor cromado en rebosadero.

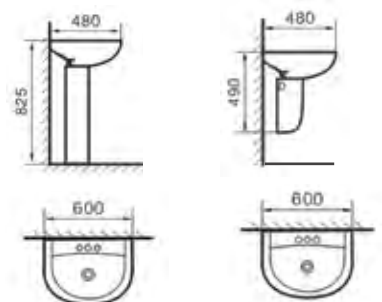



Marsella



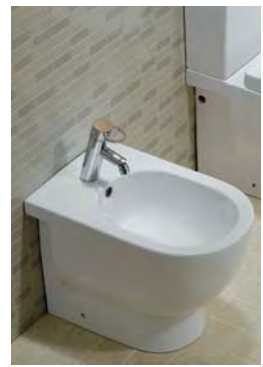

Ref. 100.20.00014
 Ref. 100.20.00014C (compacto)
 Ref. 100.20.00014S (suspensionado)

Taza inodoro con evacuación vertical / horizontal.
 Codo completo de conversión a salida vertical.
 Entrada agua inferior lateral der/izq.
 Tanque con mecanismo completo economizador 3/6 l.
 Fijaciones a suelo, asiento y tanque.
 Asiento ABS con caída amortiguada.
 Asiendo Duroplast con caída amortiguada.
 Taza prevista de orificio lateral.

Ref. 100.20.00015

Bidé completo.
 Fijaciones al suelo.
 Embellecedor cromado en rebosadero.

Ref. 100.20.00016

Lavabo con pedestal.
 Fijaciones al suelo y pared.
 Embellecedor cromado en rebosadero.

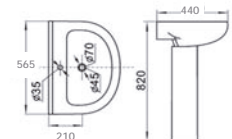
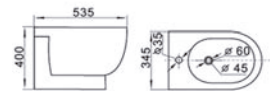
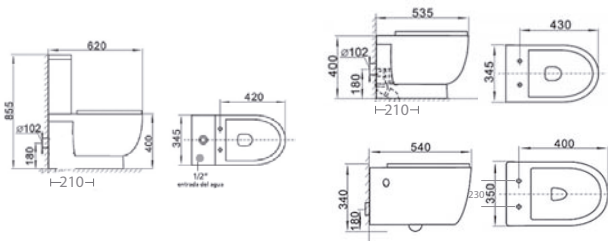



Oporto





Ref. 100.20.00007V (vertical)
Ref. 100.20.00007H (horizontal)

- Taza inodoro con evacuación vertical/horizontal.
- Entrada de agua inferior o lateral de la cisterna.
- Tanque con mecanismo completo economizador 3/6l.
- Fijaciones asiento y tanque.
- Fijaciones a suelo.
- Asiento ABS con caída amortiguada.

Ref. 100.20.00008

- Bidé completo.
- Fijaciones a suelo.
- Embellecedor cromado en rebosadero.

Ref. 100.20.000016

- Lavabo con pedestal.
- Fijaciones a suelo y pared.
- Embellecedor cromado en rebosadero.

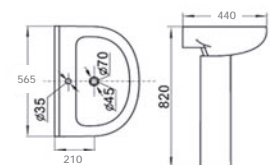
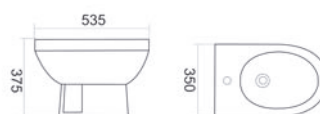
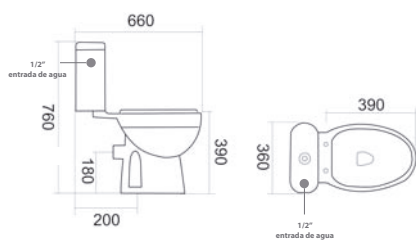



Frogy





Ref. 100.20.00012V
Ref. 100.20.00012

Taza inodoro con evacuación vertical
Taza cerámica
Tapa cisterna en ABS
Fijaciones al suelo
Mecanismo incluido

Ref. 100.20.0001
Ref. 100.20.00013

Lavabo cerámico
Fijaciones a la pared
Embellecedor en rebosadero
Fijaciones al suelo
Mecanismo incluido

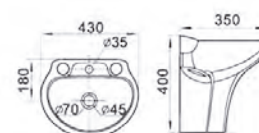
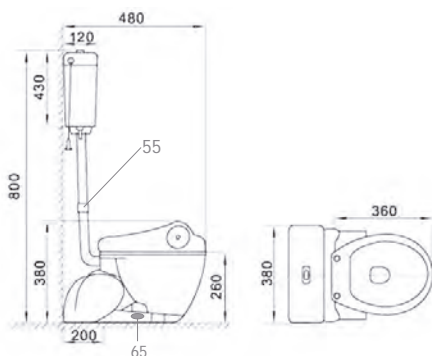

Lavabos



Ref. 100.20.00044

Lavabo sobre encimera
Porcelana vítrea
50 x 50 x 14,5 cm

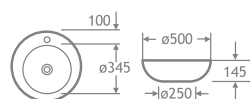

Ref. 100.20.0045

Lavabo sobre encimera
Porcelana vítrea
41 x 41 x 16,5 cm



Ref. 100.20.00046

Lavabo sobre encimera
Porcelana vítrea
41 x 41 x 15 cm



Ref. 100.20.00047

Lavabo sobre encimera
Porcelana vítrea
46 x 46 x 11 cm



Ref. 100.20.00048

Lavabo sobre encimera
Porcelana vítrea
48 x 47,5 x 16 cm



Ref. 100.20.00049

Lavabo sobre encimera
Porcelana vítrea
47 x 47 x 16 cm

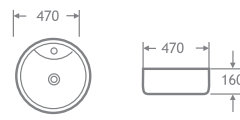



Ref. 100.20.00050

Lavabo sobre encimera
Porcelana vítrea
65 x 43 x 11 cm

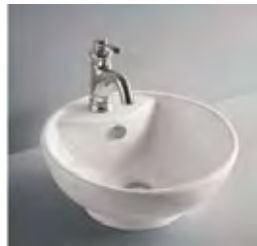
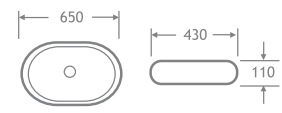

Ref. 100.20.00051

Lavabo sobre encimera
Porcelana vítrea
45 x 45 x 18 cm

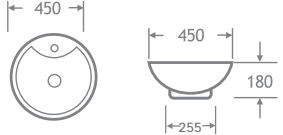

Ref. 100.20.00052

Lavabo sobre encimera
Porcelana vítrea
50 x 50 x 15,5 cm

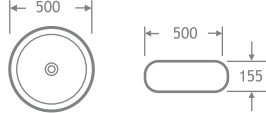

Ref. 100.20.00080

Lavabo sobre mueble
Porcelana vítrea
61 x 46 x 18 cm
* medidas aproximadas

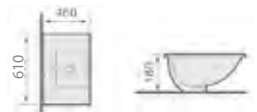

Ref. 100.20.00053

Lavabo sobre encimera
Porcelana vítrea
59,5 x 49,5 x 16 cm

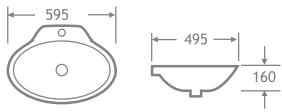

Ref. 100.20.00054

Lavabo sobre encimera
Porcelana vítrea
50 x 43 x 13 cm

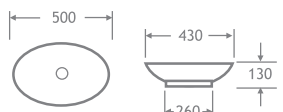

Ref. 100.20.00055

Lavabo sobre encimera
Porcelana vítrea
41 x 41 x 11 cm

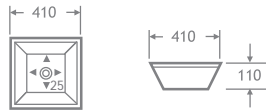

Ref. 100.20.00081

Lavabo sobre mueble
Porcelana vítrea
81 x 46 x 18 cm
* medidas aproximadas



Ref. 100.20.00056

Lavabo sobre encimera
Porcelana vítrea
46 x 46 x 16 cm

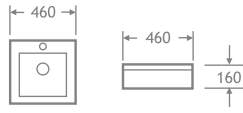

Ref. 100.20.00057

Lavabo sobre encimera
Porcelana vítrea
56 x 45 x 15 cm

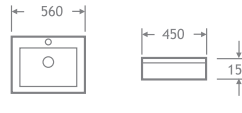

Ref. 100.20.00070

Lavabo de encastre
Porcelana vítrea
57 x 46 x 20 cm

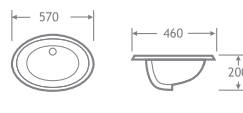

Ref. 100.20.00071

Lavabo bajo encastre
Porcelana vítrea
51 x 41 x 22 cm

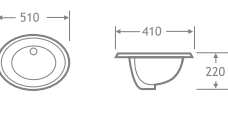

Ref. 100.20.00082

Lavabo sobre mueble
Porcelana vítrea
101 x 46 x 18 cm
* medidas aproximadas

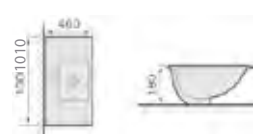

Ref. 120.20.00020

Pila lavadero
Porcelana vítrea
39 x 61,5 x 29 cm

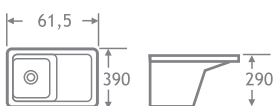

Ref. 120.20.00021

Soporte pila lavadero
Acero laminado en frío
Pintura blanca al exposipoliéster



Ref. 100.20.00046

Válvula.
Medidas estandar



Ref. 100.20.00047

Sifón.
Medidas estandar



Ref. 100.20.00083

Lavabo sobre mueble
Porcelana vítrea
121 x 46 x 18 cm
* medidas aproximadas

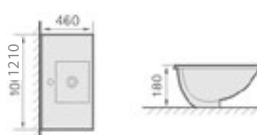



Platos de ducha cerámicos

Rectangular

Nota: Los desagües de todos los platos extraplano y 70 x 140 cm , 80 x 140 cm están centrados en el lateral esmaltado



Normal



Extraplano

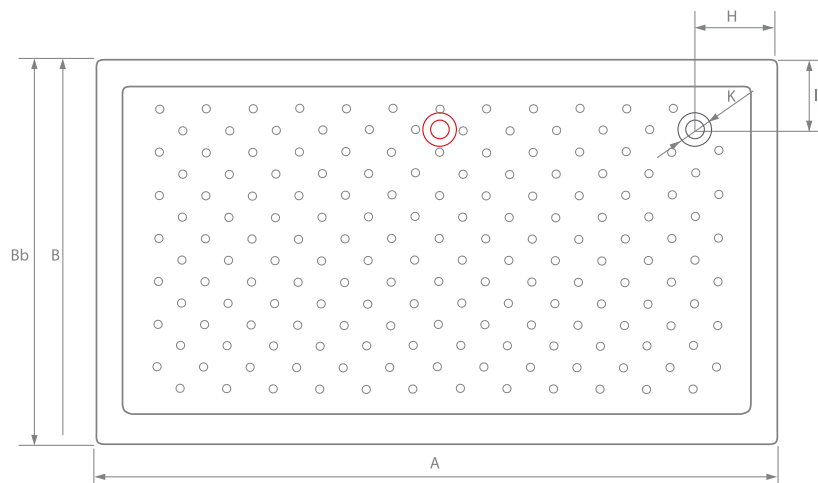

*Material cerámico

Fondo	Referencia	Tamaño/cm	A	Aa	B	Bb	C	D	E	H	I	J	K	Peso/kg
Normal	110.20.00106	72x90	900	905	720	725	60	90	≥60	270	450	780	63	27
	110.20.00107	70x100	1000	1005	700	705	60	90	≥60	190	190	880	63	31
	110.20.00108	70x120	1200	1210	700	710	70	110	≥60	190	190	1060	63	39
	110.20.00109	70x140	1400	1410	700	710	70	110	≥60	180	-	1260	-	56
	110.20.00110	80x100	1000	1010	800	810	70	95	≥60	190	190	860	63	32
	110.20.00111	80x120	1200	1210	800	810	70	110	≥60	190	190	1060	63	44
	110.20.00112	80x140	1400	1410	800	810	70	110	≥60	180	-	1260	-	63
Extraplano	110.20.00117	70x100	1000	-	700	-	60	65	20	180	-	880	-63±2	32
	110.20.00118	70x120	1200	-	700	-	70	65	20	180	-	860	-63±2	43
	110.20.00119	80x100	1000	-	800	-	70	65	20	180	-	860	-63±2	35
	110.20.00120	80x120	1200	-	800	-	70	65	20	180	-	1060	-63±2	48

Cuadrado

* Cara no esmaltada



Normal



Extraplano

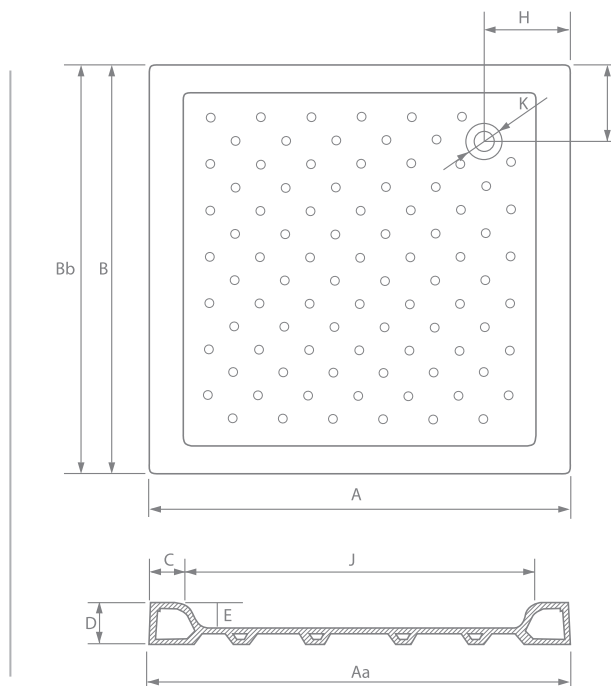

*Material cerámico

Fondo	Referencia	Tamaño	A	Aa	B	Bb	C	D	E	H	I	J	K	Peso kg
Normal	110.20.00100	72x72	720	725	720	725	65	90	≥60	170	170	590	63	20
	110.20.00101	75x75	750	755	750	755	60	90	≥60	190	190	630	63	26
	110.20.00102	80x80	800	805	800	805	60	90	≥60	190	190	630	63	26
	110.20.00103	90x90	900	905	900	905	65	95	≥60	190	190	770	63	35
Extraplano	110.20.00115	90x90	900	-	900	-	65	65	20	210	-	770	-63±2	34
	110.20.00113	80x80	800	-	800	-	65	65	20	200	-	630	63	30

* Curva tipo italiana



Normal



Extraplano

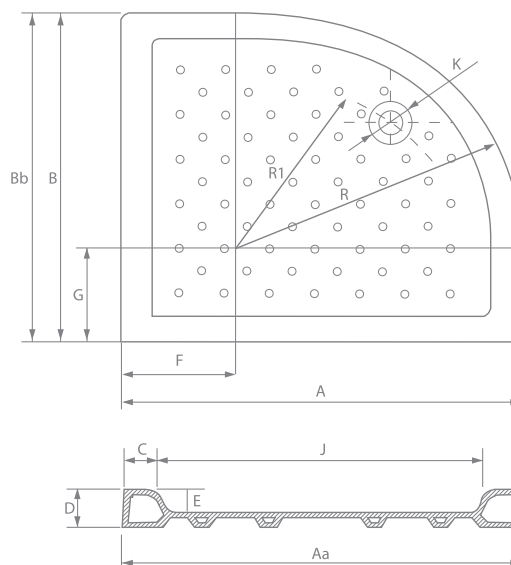

*Material cerámico

Fondo	Referencia	Tamaño/cm	A	Aa	B	Bb	C	D	E	H	I	J	K	R1	R	Peso/kg
Normal	110.20.00104	80x80	800	805	800	805	60	90	≥60	230	230	680	63	430	570	26
	110.20.00105	90x90	900	905	900	905	65	95	≥60	310	310	770	63	410	570	33
Extraplano	110.20.00116	90x90	900	-	900	-	65	65	20	-	-	770	∅63±2	550	36	

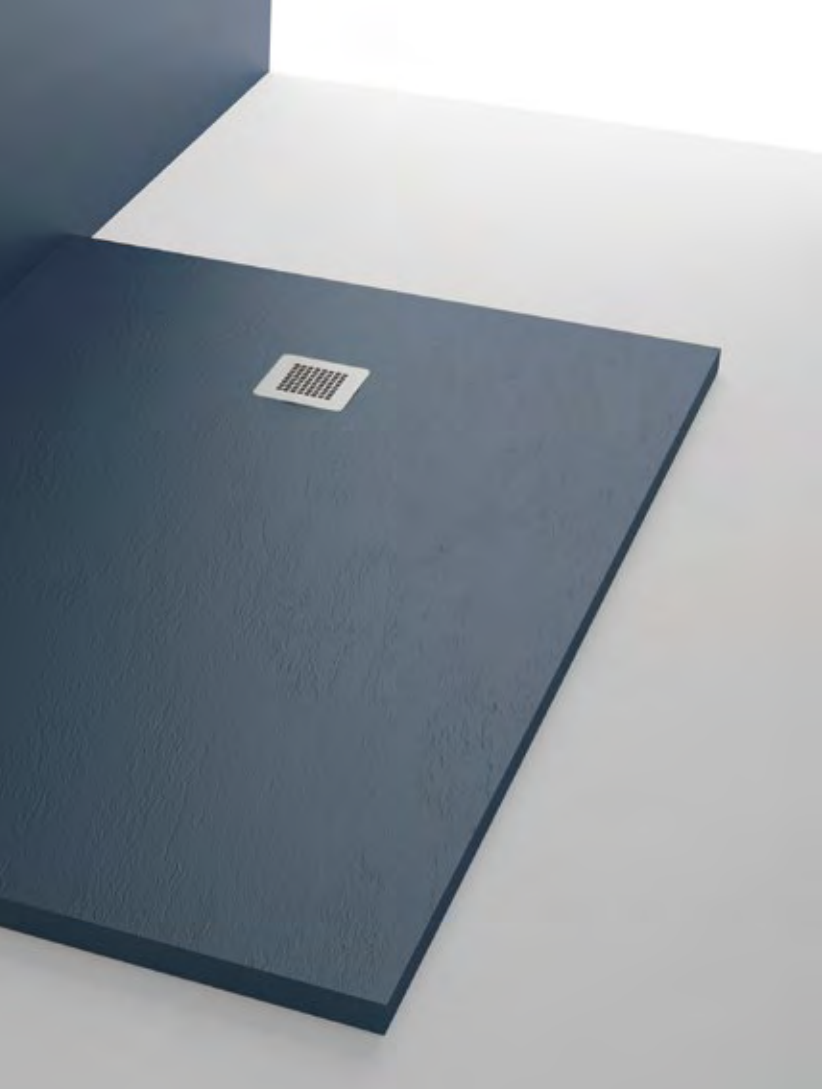

Platos de ducha resina
Textura pizarra

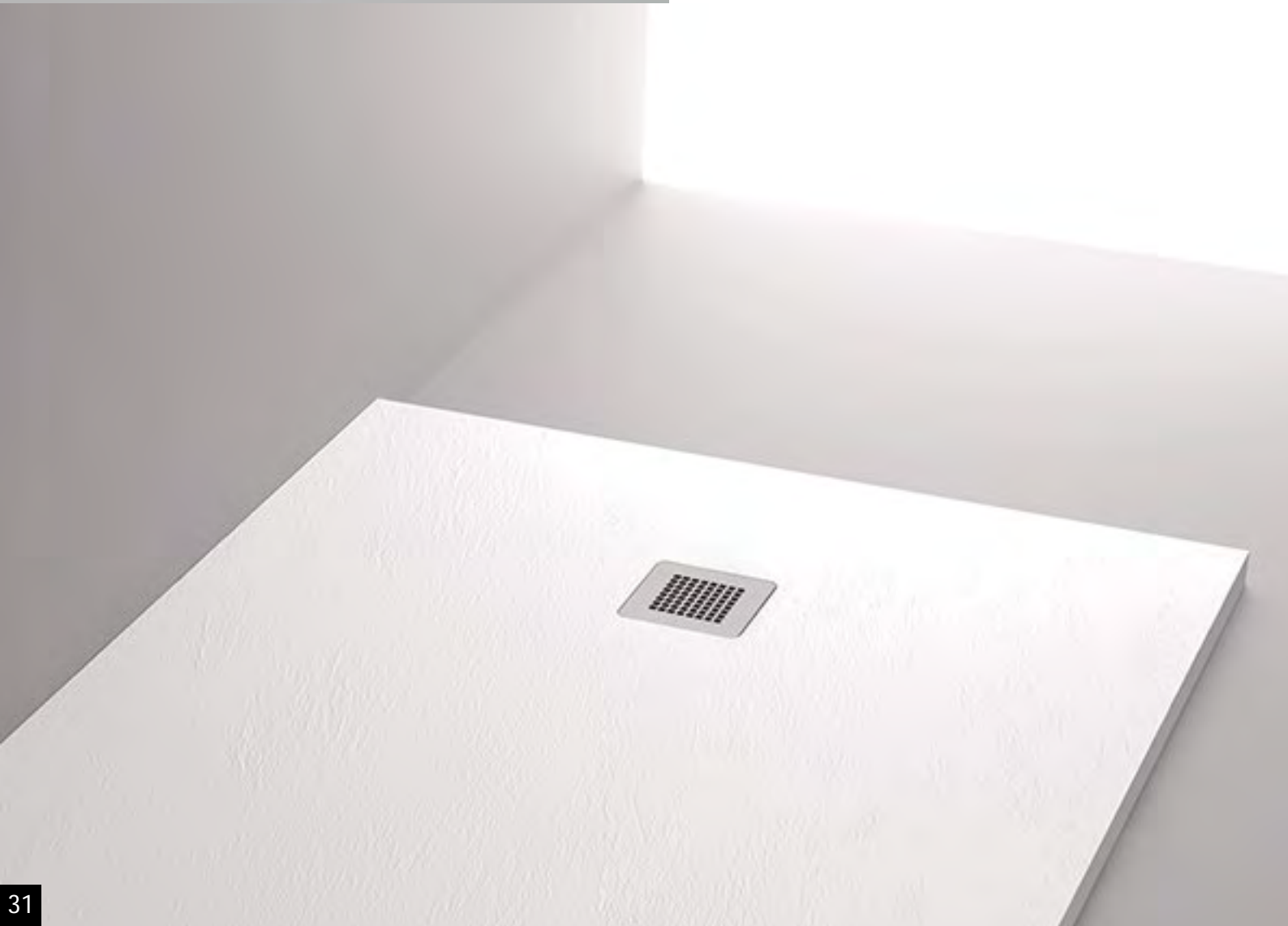



Antracita
RAL 7015



Gris
RAL 7040



Chocolate
RAL 8011



Blanco
RAL 9003



Marfil
RAL 1013



Malva
RAL 4006



Negro
RAL 9005



Rojo
RAL 3020

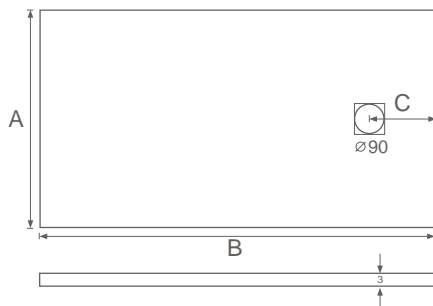

		B									
		80	90	100	120	140	160	170	180	190	200
A	70	-	-	50*	30	30	30	30	30	30	-
	80	40*	-	50*	30	30	30	30	30	30	-
	90	-	45*	50*	30	30	30	-	-	-	30
	100	-	-	50*	30	30	30	30	30	30	30
		C									

* Desagüe c. entr. al. Medidas en cm

Tabla de resistencia a productos abrasivos

Producto	Tiempo de exposición	Resultado
Lejía	24 h	SI
Cillit Bang	24 h	SI
Vinagre	24 h	SI
Limón	24 h	SI
Amoniaco	24 h	SI
Acetona	24 h	SI
Antical	24 h	SI
Alcohol	24 h	SI
Betadine	24 h	SI
Tinte Cabello	1 h	NO

2 años de garantía.

Fabricado en España.

Solo 3 centímetros de grosor.

Textura pizarra.

Amplia gama de colores estándar

Personalización de color según RAL.

Evacuación de agua de 0,8 litros/segundo.

Desnivel de 1,5 cm al desagüe.

Compuesto por resina y cargas minerales.

Pigmentado en masa.

Facilmente adaptable.

Antideslizante.

Antibacteriano.

Resistente.

No poroso.

Macizo.

Desagüe en acero inox o en colores (RAL)

* Para cortes especiales requerirá explicación sobre el tipo de corte (con terminación o sin terminación) y lado del corte. Se debe enviar esta información junto al pedido. esta información junto al pedido.



Platos de ducha resina
Textura piedra





Antracita
RAL 7015



Gris
RAL 7040

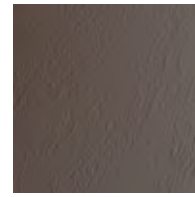

Chocolate
RAL 8011



Blanco
RAL 9003



Marfil
RAL 1013



Malva
RAL 4006



Negro
RAL 9005



Rojo
RAL 3020

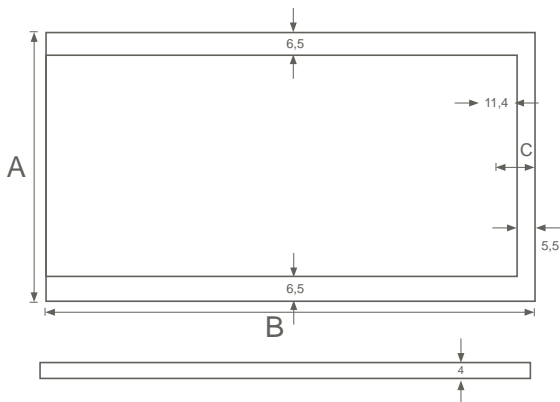

		B					
		120	140	160	180	190	200
A	80	13	13	13	13	13	13
	90	13	13	13	13	13	13
	100	13	13	13	13	13	13
		C					

Tabla de resistencia a productos abrasivos

Producto	Tiempo de exposición	Resultado
Lejía	24 h	SI
Cillit Bang	24 h	SI
Vinagre	24 h	SI
Limón	24 h	SI
Amoniaco	24 h	SI
Acetona	24 h	SI
Antical	24 h	SI
Alcohol	24 h	SI
Betadine	24 h	SI
Tinte Cabello	1 h	NO

- 2 años de garantía.
- Fabricado en España.
- Solo 4 centímetros de grosor.
- Textura piedra.
- Amplia gama de colores estándar
- Personalización de color según RAL.
- Evacuación de agua de 0,8 litros/segundo.
- Desnivel de 1,5 cm al desagüe.
- Compuesto por resina y cargas minerales.
- Pigmentado en masa.
- Facilmente adaptable.
- Antideslizante.
- Antibacteriano.
- Resistente.
- No poroso.
- Macizo.
- Desagüe en acero inox o en colores (RAL)

* Para cortes especiales requerirá explicación sobre el tipo de corte (con terminación o sin terminación) y lado del corte. Se debe enviar esta información junto al pedido.



Sena

Acabado	Ancho (mm)	Rango (mm)	A	Rango (mm)	B	Apertura (mm)	C
CUADRADO transparente	800 x 800	775-800		775-800		415	
CUADRADO transparente	900 x 900	875-900		875-900		480	
RECTANGULAR transparente	800 x 1000	975-1000		775-800		485	
RECTANGULAR transparente	800 x 1200	1175-1200		775-800		560	
RECTANGULAR transparente	700 x 1000	975-1000		675-700		460	
RECTANGULAR transparente	700 x 1200	1175-1200		675-700		535	
PERFIL COMPENSACIÓN	60	0-50					
TUBO COMPENSACIÓN CUADRADO	40 X 40 X 1950						
TUBO COMPENSACIÓN RECTANGULAR	20 X 40 X 1950						

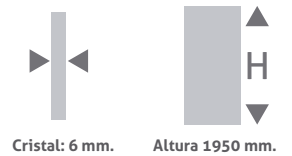

* Ancho de perfil (4 cm)

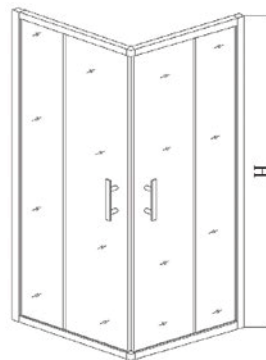
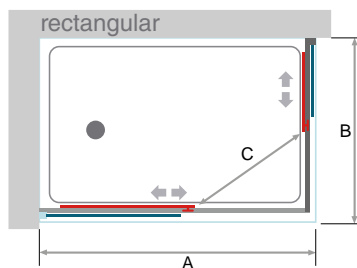

* Puertas y laterales reversibles

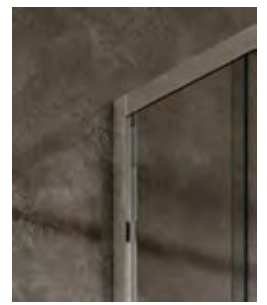

Acabado	Ancho (mm)	Rango (mm) A	Apertura (mm) C
FRONTAL FIJO + PUERTA transparente	1100	1050-1100	440
FRONTAL FIJO + PUERTA transparente	1200	1150-1200	490
FRONTAL FIJO + PUERTA transparente	1300	1250-1300	540
FRONTAL FIJO + PUERTA transparente	1400	1350-1400	590
FRONTAL FIJO + PUERTA transparente	1500	1450-1500	640
FRONTAL FIJO + PUERTA transparente	1600	1550-1600	690
FRONTAL FIJO + PUERTA transparente	1700	1650-1700	690
FRONTAL 2 FIJOS + 2 PUERTAS trans.	1200	1150-1200	435
FRONTAL 2 FIJOS + 2 PUERTAS trans.	1400	1350-1400	535
FRONTAL 2 FIJOS + 2 PUERTAS trans.	1600	1550-1600	635
FRONTAL 2 FIJOS + 2 PUERTAS trans.	1800	1750-1800	735
FIJO TRANSPARENTE	700	690-710	650
FIJO TRANSPARENTE	800	790-810	650
Perfil de compensación	60	0-50	
TUBO COMPENSACIÓN CUADRADO	40 x 40 x 1950		
TUBO COMPENSACIÓN RECTANGULAR	20 x 40 x 1950		

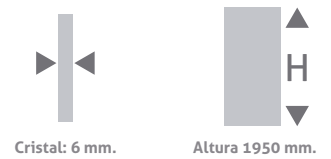

frontal
2 fijos + 2 puertas

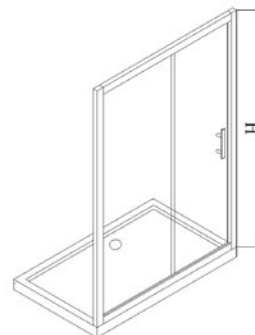
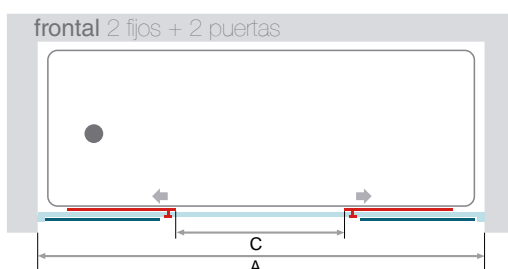

frontal

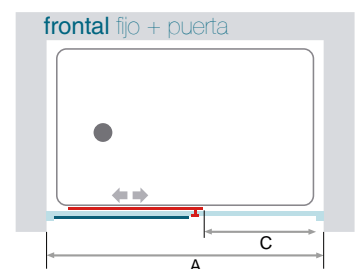

* Puertas y laterales reversibles



Nilo

Acabado	Ancho (mm)	Rango (mm) A	Rango (mm) B	Apertura (mm) C
CUADRADO transparente	800 x 800	775-800	775-800	435
CUADRADO transparente	900 x 900	750-900	875-900	505
RECTANGULAR transparente	800 x 1000	775-800	975-1000	515
RECTANGULAR transparente	800 x 1200	775-800	1175-1200	585
RECTANGULAR transparente	700 x 900	675-700	875-900	430
RECTANGULAR transparente	700 x 1000	675-700	975-1000	480
RECTANGULAR transparente	700 x 1200	675-700	1175-1200	550
RECTANGULAR transparente	700 x 1400	675-700	1370-1400	660
SEMICIRCULAR transparente	800 x 800	775-800	775-800	430
SEMICIRCULAR transparente	900 x 900	875-900	875-900	490
RECTANGULAR serigrafiado	700 x 900	675-700	875-900	430
RECTANGULAR serigrafiado	700 x 1000	675-700	975-1000	480
RECTANGULAR serigrafiado	700 x 1200	675-700	1175-1200	550
RECTANGULAR serigrafiado	700 x 1000	775-800	975-1000	515
RECTANGULAR serigrafiado	800 x 1200	775-700	1175-1200	585
SEMICIRCULAR serigrafiado	800 x 800	775-800	775-800	430
SEMICIRCULAR serigrafiado	900 x 900	875-900	875-900	490

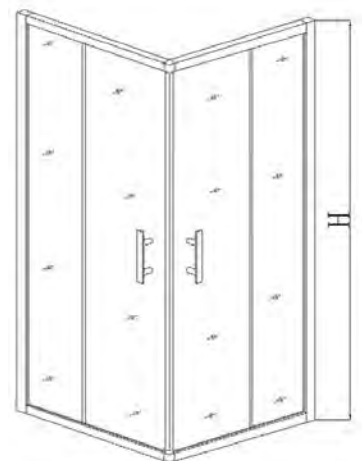
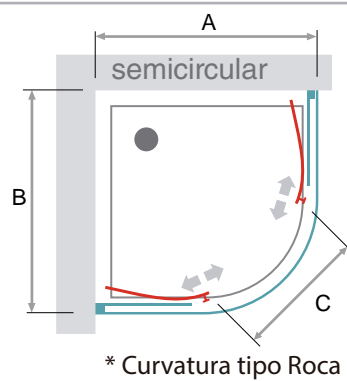
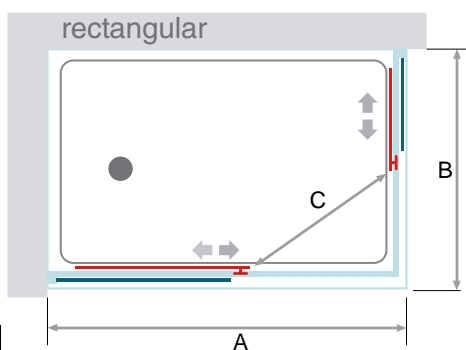
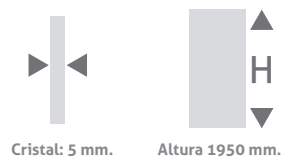



Acabado	Ancho (mm)	Rango (mm) A	Rango (mm) B	Apertura (mm) C
FRONTAL FIJO + PUERTA trans.	1000	960-1000		375
FRONTAL FIJO + PUERTA trans.	1100	1060-1100		425
FRONTAL FIJO + PUERTA trans.	1200	1160-1200		475
FRONTAL FIJO + PUERTA trans.	1300	1260-1300		525
FRONTAL FIJO + PUERTA trans.	1400	1360-1400		575
FRONTAL FIJO + PUERTA trans.	1500	1460-1500		625
FRONTAL FIJO + PUERTA trans.	1600	1560-1600		675
FRONTAL FIJO + PUERTA trans.	1700	1660-1700		675
FIJO transparente	700	675-700		
FIJO transparente	800	775-800		
FRONTAL FIJO + PUERTA serig.	1100	1060-1100		425
FRONTAL FIJO + PUERTA serig.	1200	1160-1200		475
FRONTAL FIJO + PUERTA serig.	1300	1260-1300		525
FRONTAL FIJO + PUERTA serig.	1400	1360-1400		575
FRONTAL FIJO + PUERTA serig.	1500	1460-1500		625
FRONTAL FIJO + PUERTA serig.	1600	1560-1600		675
FRONTAL FIJO + PUERTA serig.	1700	1660-1700		675
FIJO transparente	700	675-700		
FIJO transparente	800	775-800		
PERFIL COMPENSACIÓN	60	0-50		
TUBO COMPENSACIÓN CUADRADO	40x40x1950	* aumenta 20 mm la compensación normal		
TUBO COMPENSACIÓN RECTANGULAR	20x40x1950			

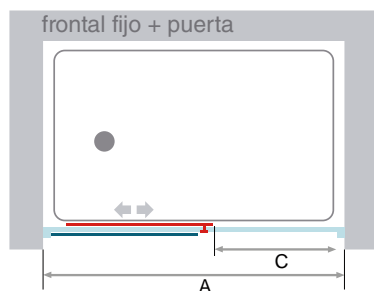
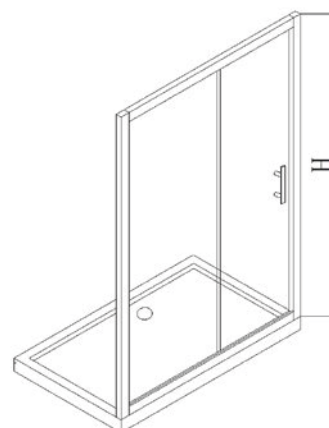
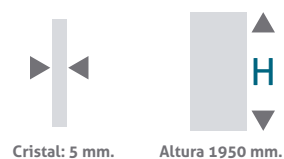

Rialto

Grifería



Ref. 110.20.00002

Monomando baño- ducha
 Cartucho 40 mm (marca Sedal)
 Acabado cromo
 Aireador con economizador incluido

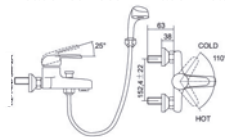

Ref. 110.20.00001

Monomando ducha
 Cartucho 40 mm (marca Sedal)
 Acabado cromo
 Aireador con economizador incluido

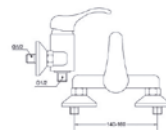

Ref. 110.20.0004

Grifería monomando bidé
 Cartucho 40 mm (marca Sedal)
 Acabado cromo
 Aireador con economizador incluido

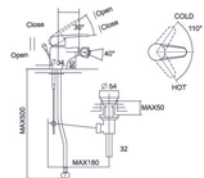

Ref. 110.20.0003

Monomando lavabo
 Cartucho 40 mm (marca Sedal)
 Acabado cromo
 Aireador con economizador incluido

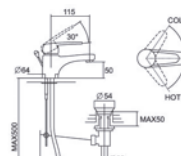

Ref. 110.20.00006

Monomando vertical de fregadero
 con caño giratorio
 Cartucho 40 mm (marca Sedal)
 Acabado cromo
 Aireador con economizador
 incluido

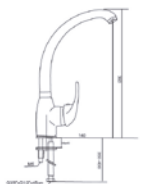



SITORAN TECHNOLOGY

Pol. Ind. Oeste
Calle Fortuna 5
30820 Alcantarilla
Murcia - España
Telf./Centralita +34968800008
mf@sitoran.com